

FLOW RATE MONITOR / TOTALIZER

WITH HIGH / LOW ALARM, ANALOG AND PULSE SIGNAL OUTPUTS



Advantages

- Robust IP67 (NEMA Type4X) field enclosure. It is so rugged, **you can even stand on it!**
- Intrinsically Safe available - ATEX and IECEx approval for gas and dust applications.
- Programming can be done by your own crew, with the sensible menu-driven structure, saving cost and irritation. **Know one, know them all!**
- Very diverse mounting possibilities: walls, pipes, panels or directly onto outdoor sensors!

Features

- Displays instantaneous flow rate, total and accumulated total.
- Four alarm values can be entered: low-low, low, high and high-high flow rate alarm.
- Large 17mm (0.67") digits for flow rate or total.
- Selectable on-screen engineering units; volumetric or mass.
- Auto backup of settings and running totals.
- Explosion/flame proof  II 2 GD EEx d IIB T5.
- Full Modbus communication RS232/485/TTL.
- Loop or battery powered, 8 - 24V AC/DC or 115 - 230V AC power supply.
- Sensor supply 3 / 8.2 / 12 / 24V DC.

Signal output

- Up to four free configurable alarm outputs.
- (o)4 - 20mA / o - 10V DC according to flow rate.
- Up to four scaled pulse outputs according to accumulated total.

Signal input

Flow

- Ability to process all types of flowmeter signals: Reed-switch, NAMUR, NPN/PNP pulse, Sine wave (coil), Active pulse signals, (o)4 - 20mA, o - 10V DC.

Applications

- The F-Series is your first and safest choice for field mount indicators. Especially in harsh weather conditions like rain, snow, salty atmospheres and temperatures between -40°C up to +80°C (-40°F up to 176°F) for safe and hazardous area applications!
- Liquid flow measurement where continues flow rate monitoring is important. Also re-transmission of the flow rate and/or totalizer functions or serial communication is required. Alternative basic model: Fo13 or more advanced F118 or the D-Series DIN panel mount flow rate indicators.

General information

Introduction

The F113 is a versatile flow rate indicator and totalizer with continuous flow rate monitoring feature. It offers the facility to set two low flow rate and two high flow rate alarm values. If desired, a delay function can be set up to allow for an incorrect flow rate for a certain period of time. Up to four outputs are available to transmit the alarm condition and/or the accumulated total. A wide selection of options further enhance this model's capabilities, including backlight, Intrinsic Safety and full Modbus communication.

Display

The display has large 17mm (0.67") and 8mm (0.31") digits which can be set to show flow rate, totals and alarm values. The alarm values can be password protected. On-screen engineering units are easily configured from a comprehensive menu. The accumulated total can register up to 11 digits and is backed-up in EEPROM memory every minute.

Configuration

All configuration settings are accessed via a simple operator menu which can be password protected. Each setting is clearly indicated with an alphanumeric description, which avoids confusing abbreviations and baffling codes. Once familiar with one F-series product, you will be able to program all models in the series without a manual. All settings are safely stored in EEPROM memory in the event of sudden power failure.

Analog output signal

The flow rate is re-transmitted with the (o)4-20mA or 0 - 10V DC output signal. The output signal is updated eight times per second with a filter function being available to smoothen out the signal if desired.

The output value is user defined in relation to the flow rate, e.g. 4mA equals to 15L/Hr and 20mA equals to 2000L/Hr. The output signal can be passive, active or isolated where the passive output type will loop power the F113 as well.

Pulse output

The scaleable pulse output, reflects the count on the accumulated display. The pulse length is user defined and the max. output frequency is 500Hz.

Signal input

The F113 accepts most pulse and analog input signals for volumetric flow or mass flow measurement. The input signal type can be selected by the user in the configuration menu without having to adjust any sensitive mechanical dip-switches or jumpers. The analog input is available with linear and square root calculation and even as 4 - 20mA input loop powered.

Communication

All process data and settings can be read and modified manually or through the Modbus communication link (RS232 / RS485). Full Modbus functionality remains available for the Intrinsically Safe version (TTL).

Hazardous areas

This model has been ATEX and IECEx certified Intrinsically Safe for gas and dust applications, with an allowed ambient temperature of -40°C to +70°C (-40°F to +158°F). A flame proof enclosure with ATEX certification offers the rating $\text{Ex II 2 GD EEx d IIB T5}$.

Enclosures

Various types of enclosures can be selected, all ATEX and IECEx approved. As standard the F113 is supplied in an GRP panel mount enclosure, which can be converted to an IP67 / NEMA Type4X GRP field mount enclosure by the addition of a back case. Most popular is our rugged aluminum field mount enclosure with IP67 / NEMA Type4X rating. Both European or U.S. cable gland entry threads are available.

Overview application F113

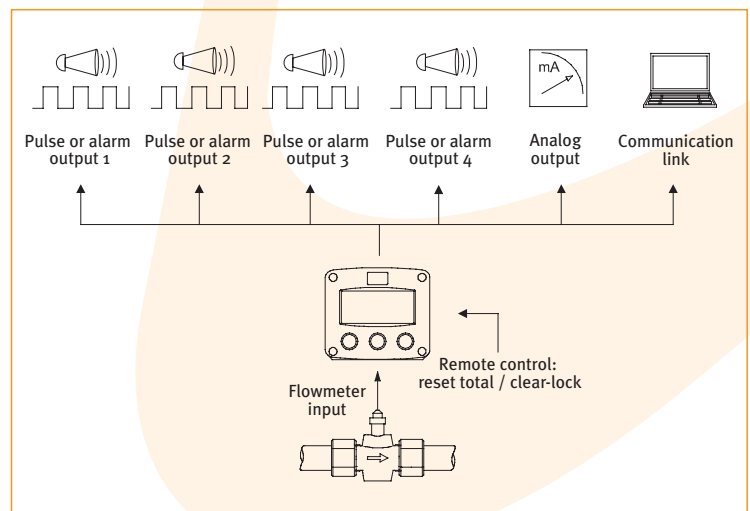

Dimensions enclosures

Aluminum & GRP panel mount enclosure

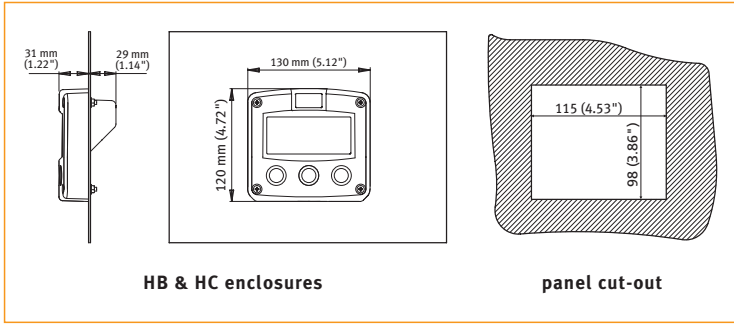

HB & HC enclosures

panel cut-out

Aluminum & GRP field / wall mount enclosures

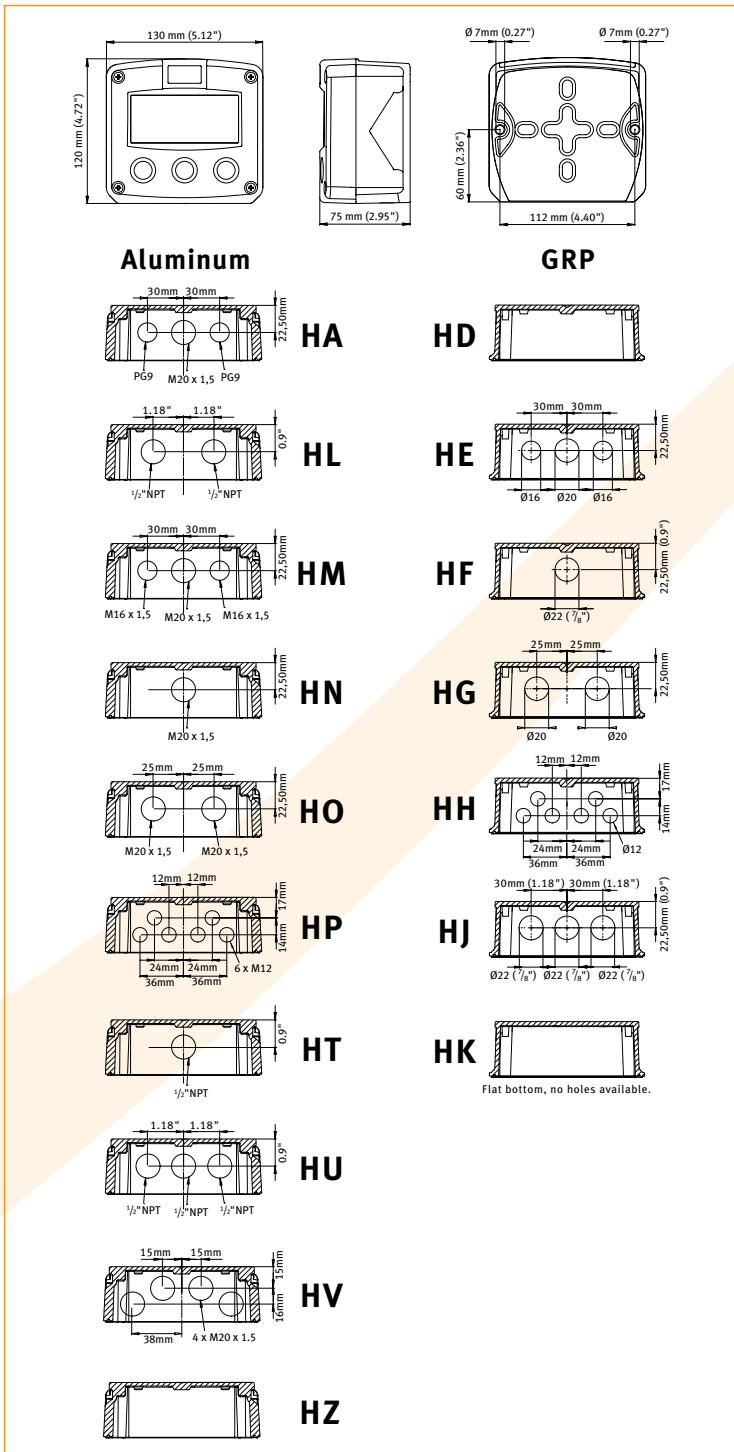

Aluminum

GRP

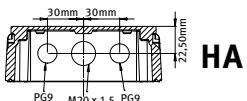

HA

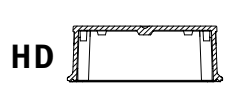

HD

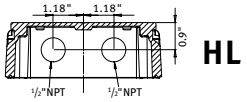

HL

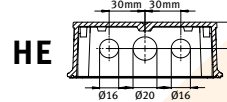

HE

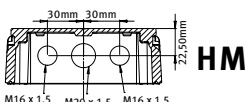

HM

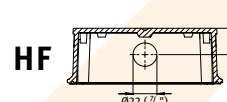

HF

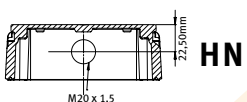

HN

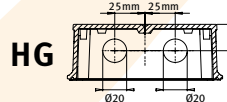

HG

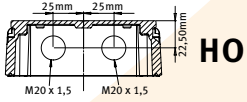

HO

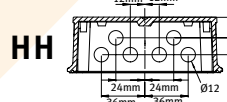

HH

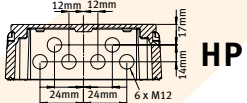

HP

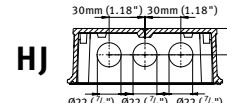

HJ

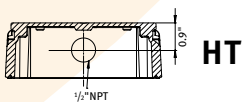

HT

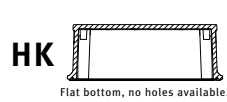

HK

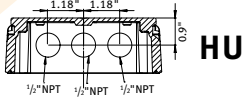

HU

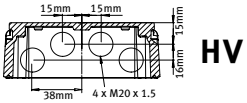

HV

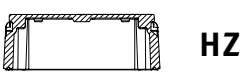

HZ

Terminal connections

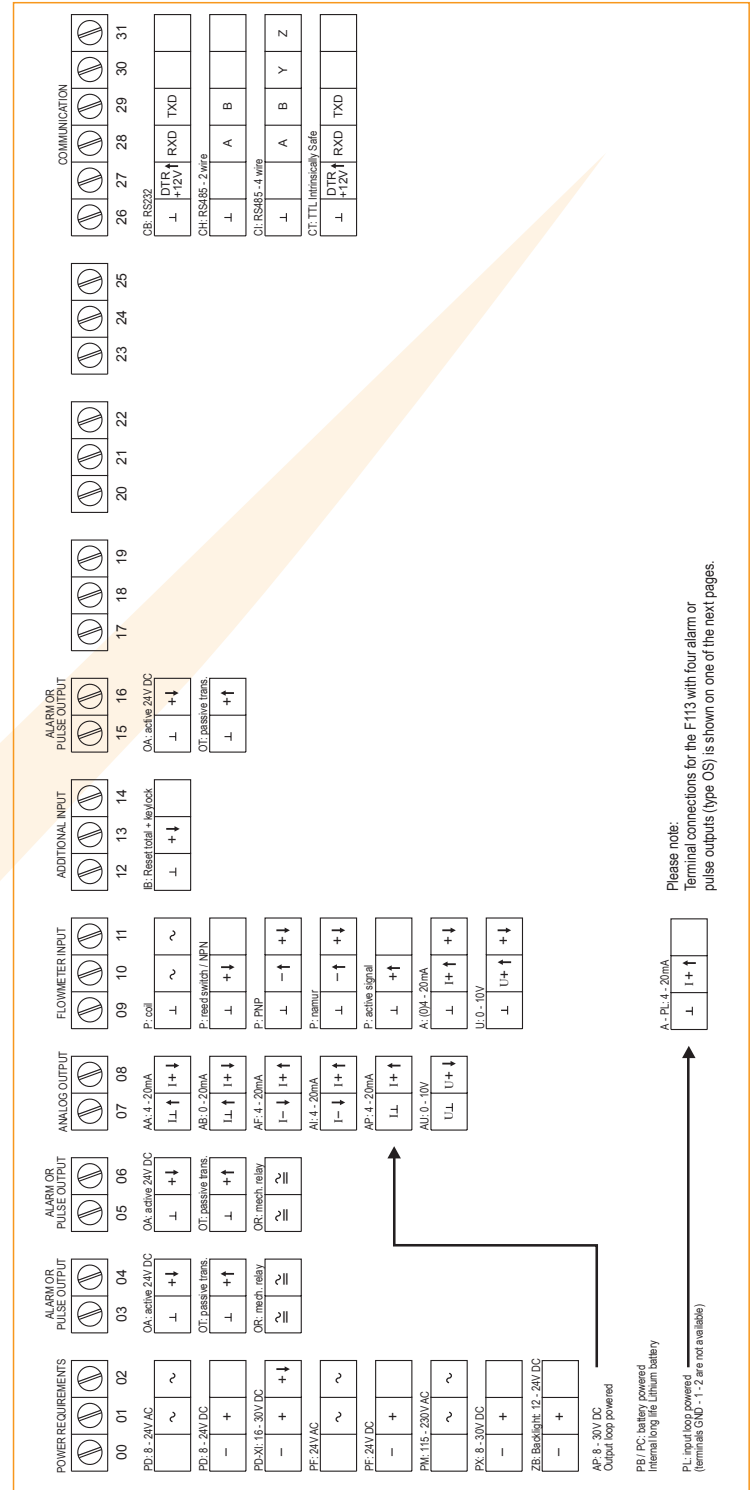

Please note:
Terminal connections for the F113 with four alarm or pulse outputs (type OS) is shown on one of the next pages.

Display example - 90 x 40mm (3.5" x 1.6")

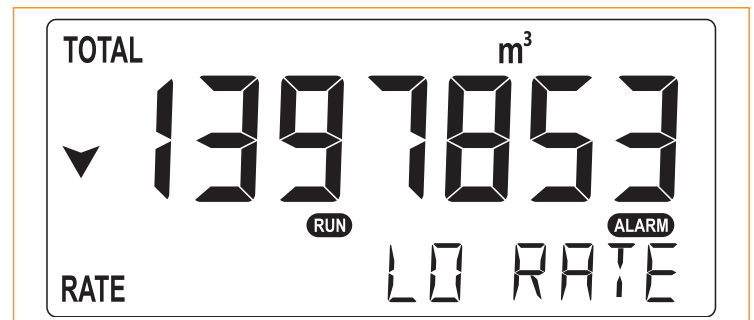

Typical wiring diagram F113-P-AP-CH-IB-OT-(PX)

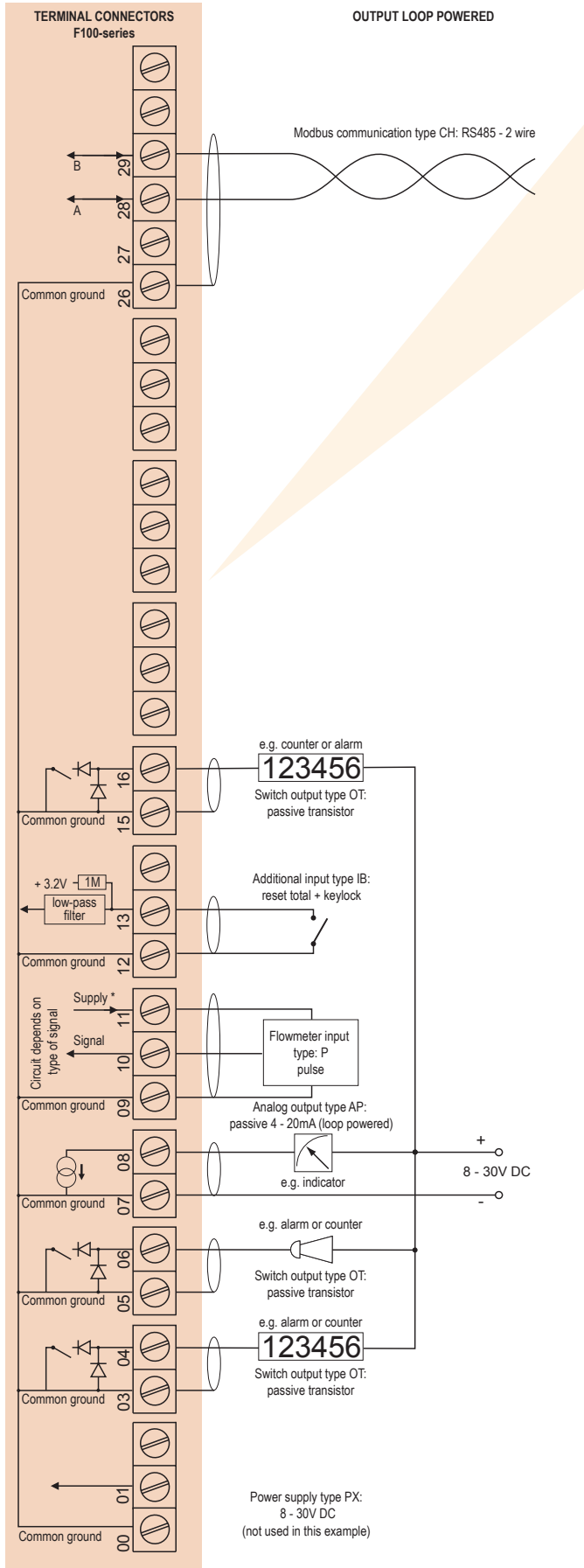

* Supply voltage: 1.2 / 3.2V DC to sensor

Typical wiring diagram F113-A-AA-CB-IB-OA-PD

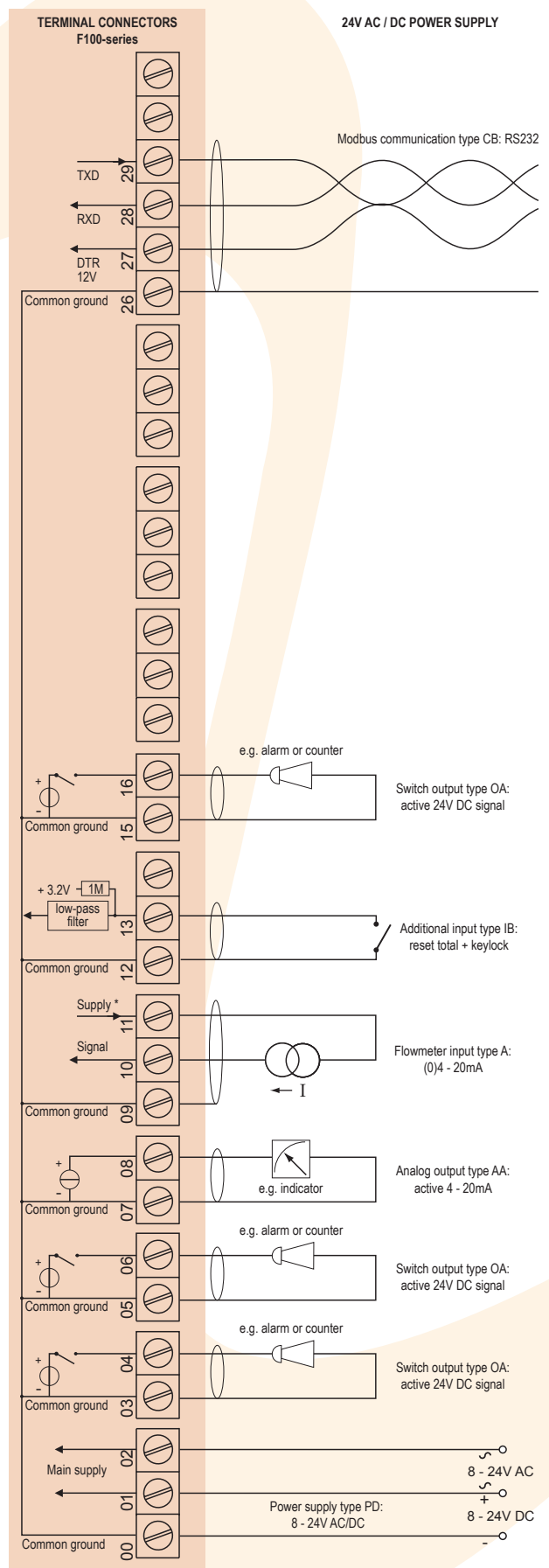

* Supply voltage: 3.2 / 8.2 / 12 / 24V DC to sensor

Typical wiring diagram F113-A-AI-CI-IB-OR-PM

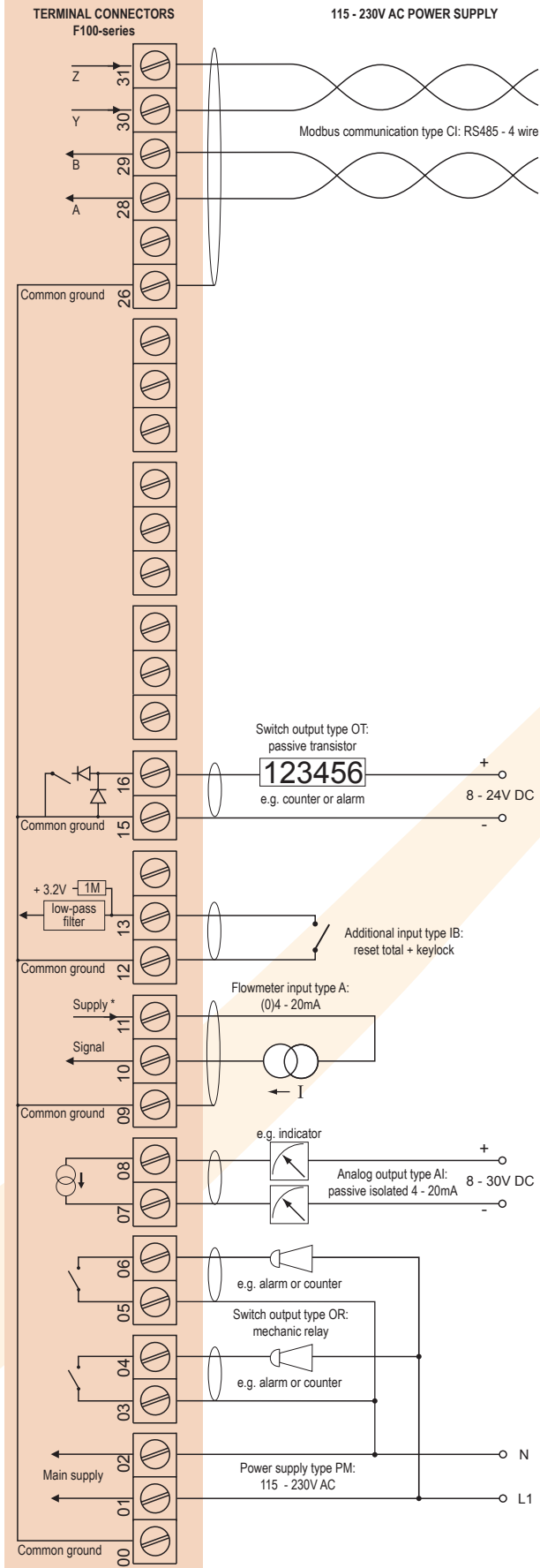

* Supply voltage: 3.2 / 8.2 / 12 / 24V DC to sensor

Typical wiring diagram F113-P-AP-CB-IB-OS-PD

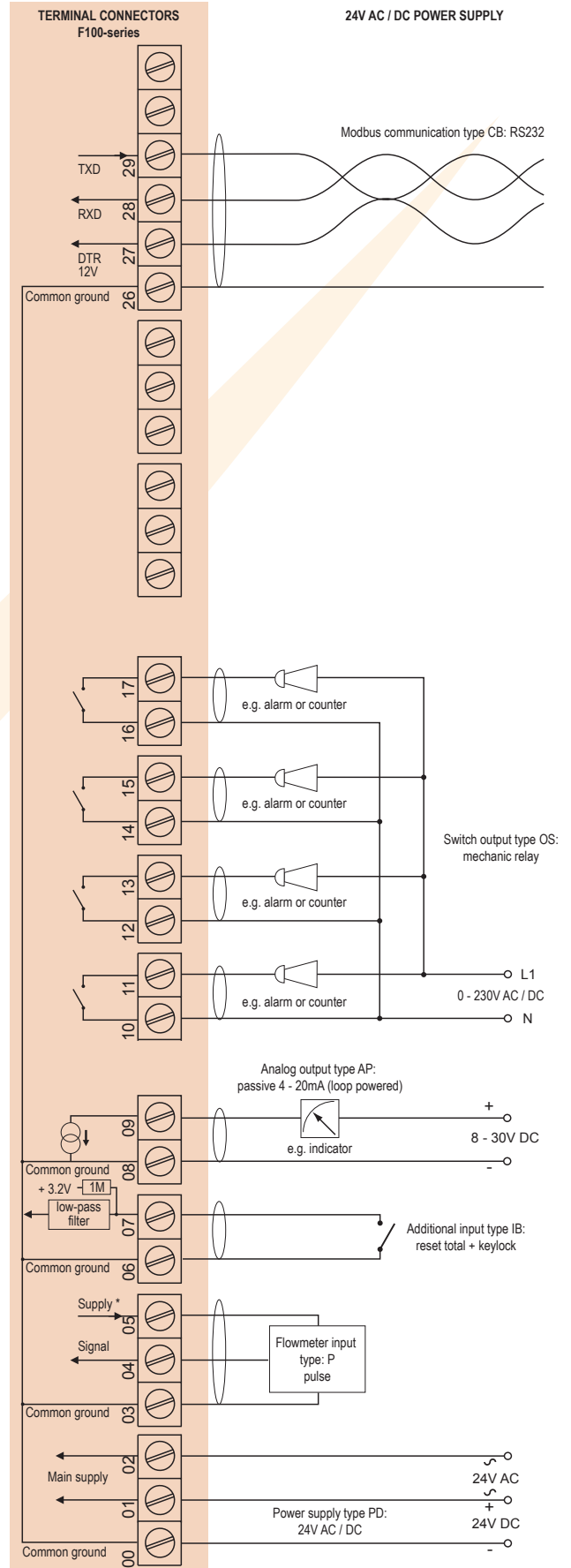

* Supply voltage: 1.2 / 3.2 / 8.2 / 12 / 24V DC to sensor

Hazardous area applications

The F113-XI has been certified according ATEX and IECEx by DEKRA for use in Intrinsically Safe applications with an ambient temperature of -40°C to +70°C (-40°F to +158°F).

- The ATEX markings for gas and dust applications are:

II 1 G Ex ia IIB/IIC T4 Ga
II 1 D Ex ia IIIC T100 °C Da.

- The IECEx markings for gas and dust applications are: **Ex ia IIC/IIB T4 Ga** and **Ex ia IIIC T100 °C Da.**

Besides the I.S. power supplies for the two alarm / pulse outputs, it is allowed to connect up to three I.S. power supplies in IIB/IIIC applications or one in IIC applications. Consult the certificate for the maximum input and output values of the circuits. Full functionality of the F113 remains available, including two alarm or pulse outputs and 4 - 20mA output and Modbus communication (type CT). Power supply type PD-XI offers a 8.2V sensor supply e.g. for one Namur sensor. A flame proof enclosure with rating ATEX **II 2 GD EEx d IIB T5** is available as well.

Please contact your supplier for further details.

Certificate of conformity KEMA 03ATEX1074 X

• IECEx DEK 11.0042X



Configuration example IIB / IIIC and IIC

F113-P-(AP)-(CT)-IB-(OT)-PC-XI - Battery powered unit

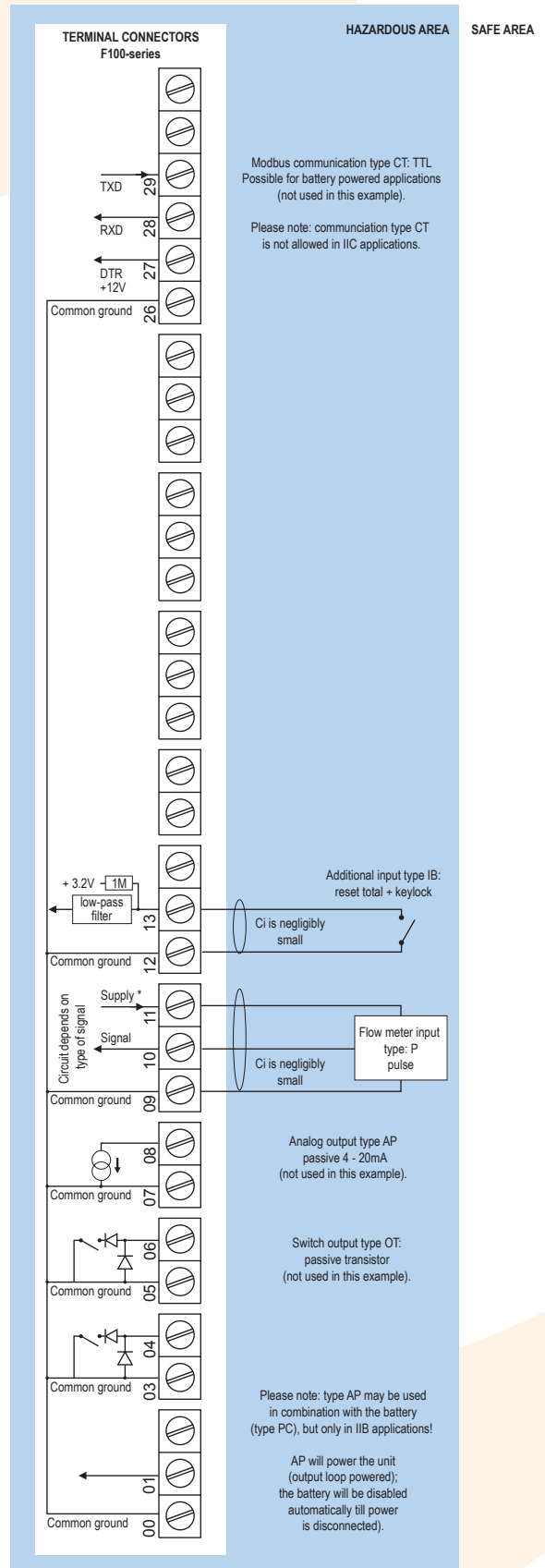

* Note sensor supply voltage: 1.2V DC for coil sensors or 3.2V DC for other pulse sensors.

Configuration example IIB / IIIC and IIC - F113-P-AP-(CT)-IB-OT-(PX)-XI - Output loop powered

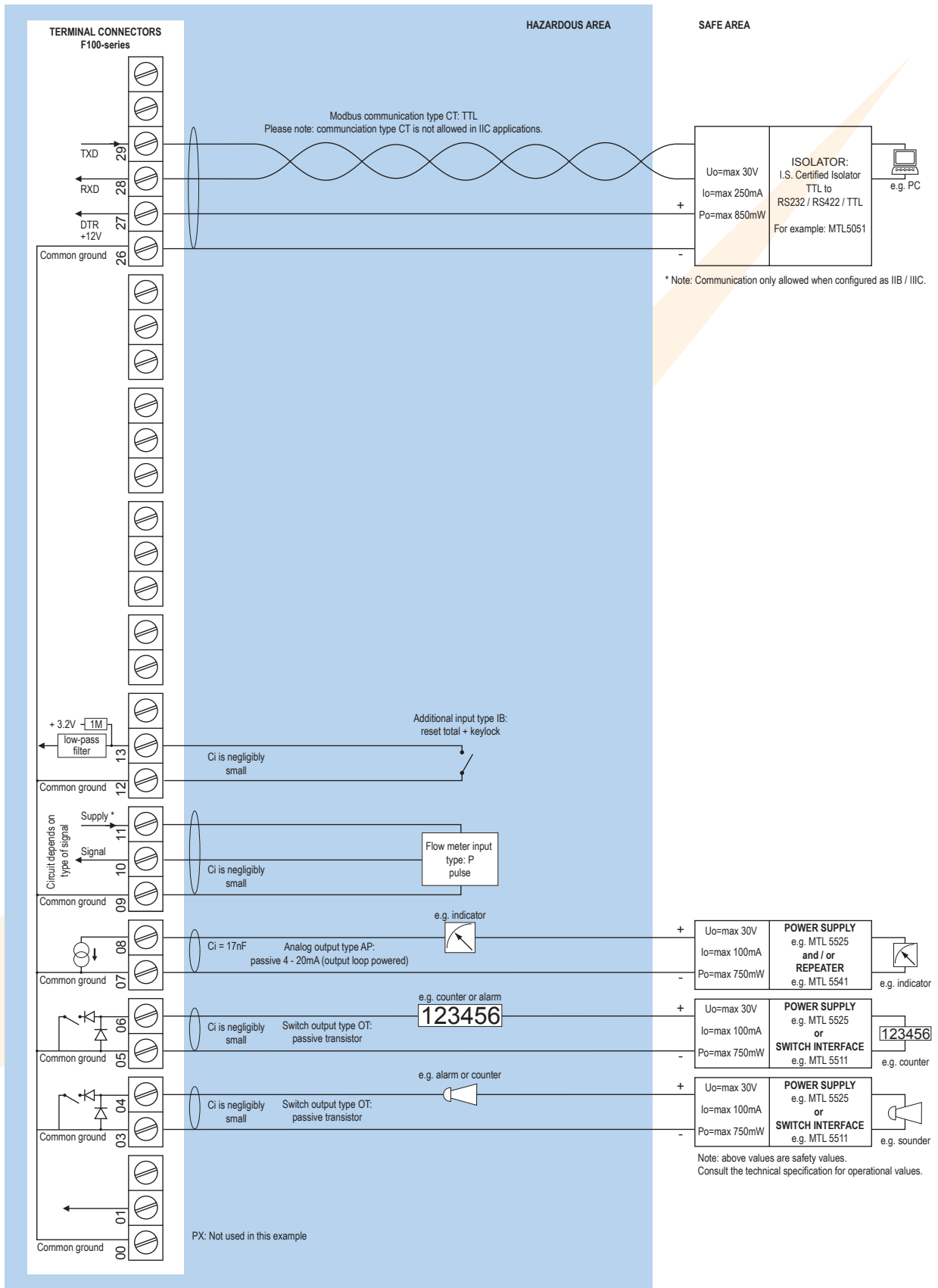

Configuration example IIB / IIIC and IIC - F113-A-AF-(CT)-IB-OT-PD-XI - Power requirement 16 - 30V DC

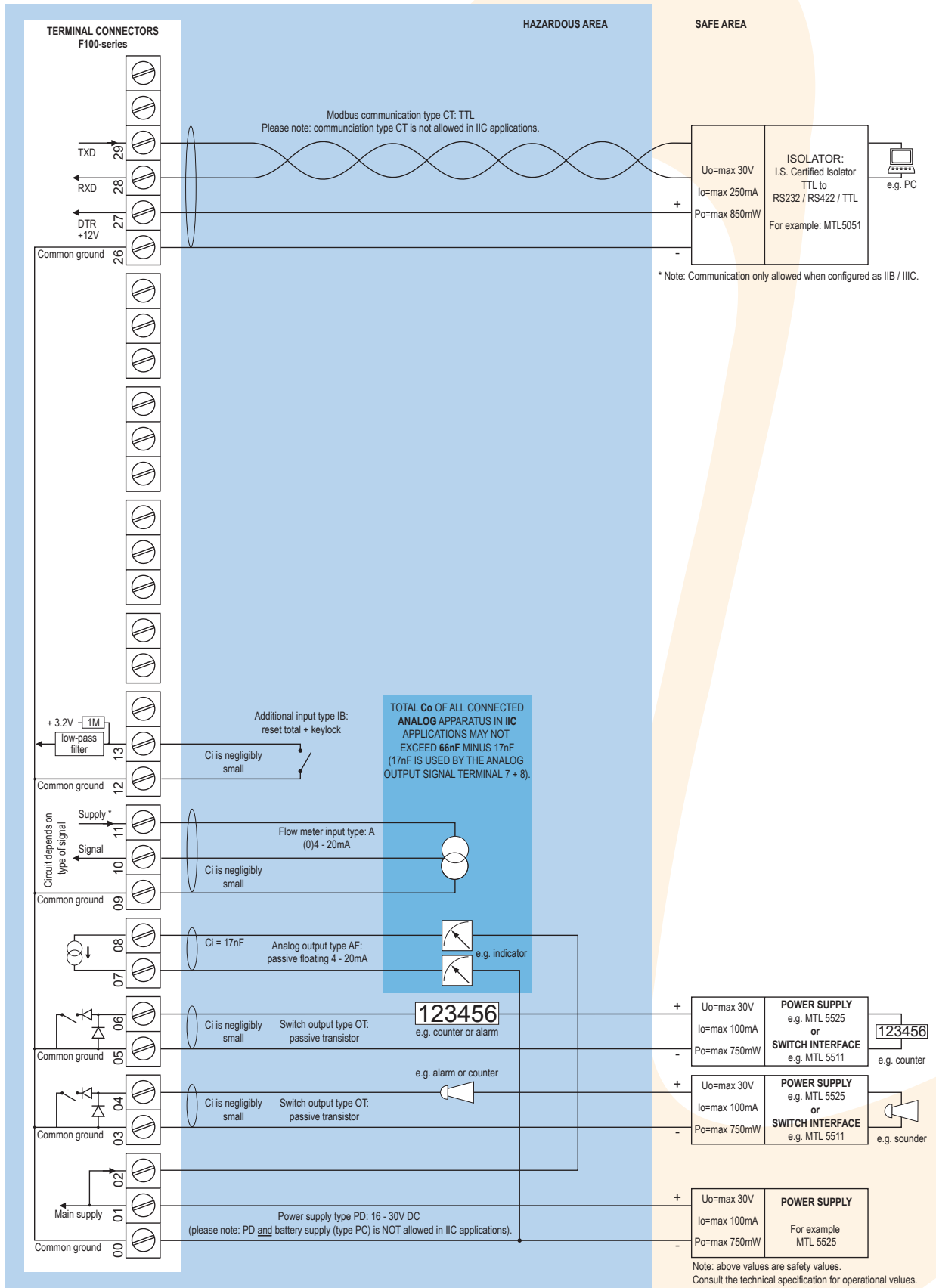

Configuration example IIB / IIIC - F113-A-AF-CT-IB-OT-(PC)-(PD)-XI - Power requirement 16 - 30V DC or battery powered

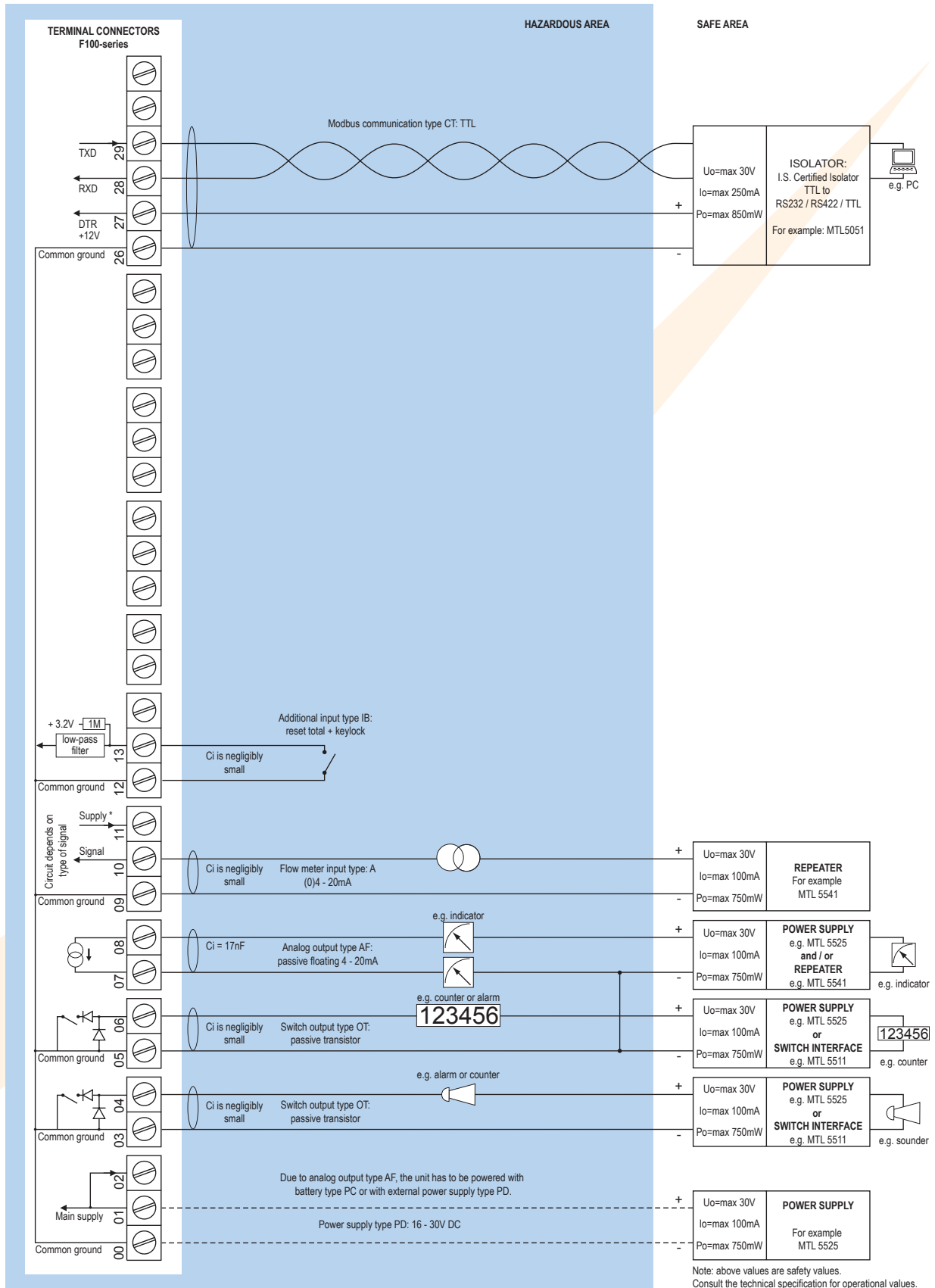

* Note power supply type PD: the supply voltage to pulse sensors is maximum 8.7V (Uo=max 8.7V Io=max 25mA Po=max 150mW) and to analog sensors as connected to terminal 1 (internally linked).

Technical specification

General

Display	
Type	High intensity reflective numeric and alphanumeric LCD, UV-resistant.
Dimensions	90 x 40mm (3.5" x 1.6").
Digits	Seven 17mm (0.67") and eleven 8mm (0.31") digits. Various symbols and measuring units.
Refresh rate	User definable: fast, 1sec, 3sec, 15sec, 30sec, off.
Option ZB	Transflective LCD with white LED-backlight. Red (flashing) backlight during alarm conditions.
Note ZB	Only available for safe area applications.

Ambient temperature

Safe areas	-40°C to +80°C (-40°F to +176°F).
Intrinsically Safe	-40°C to +70°C (-40°F to +158°F).

Power requirements

Type AP	Analog output loop powerd, 8 - 30V DC. Power consumption max 0.5 Watt.
Type PB	Long life Lithium battery - life-time depends upon settings and configuration - up to 5 years. (requires PD, PL or PX)
Type PC	Intrinsically Safe long life lithium battery - life-time depends upon settings and configuration - up to 5 years. (requires XI and PD or PX)
Type PD	8 - 24V AC / DC ± 10%. Power consumption max. 10 Watt. Intrinsically Safe: 16 - 30V DC; power consumption max. 0.75 Watt.
Type PF	24V AC / DC ± 10%. Power consumption max. 15 Watt.
Type PL	Input loop powered from sensor signal 4 - 20mA (type "A") - requires types AI and OT (not Xi).
Type PM	115 - 230V AC ± 10%. Power consumption max. 15 Watt.
Type PX	8 - 30V DC. Power consumption max. 0.5 Watt.
Type ZB	12 - 24V DC ± 10%. Power consumption max. 1 Watt.
Note PB/PF/PM	Not available Intrinsically Safe.
Note PF/PM	The total consumption of the sensors and outputs may not exceed 400mA @ 24V.
Note	For Intrinsically Safe applications, consult the safety values in the certificate.

Sensor excitation

Type PB/PC/PX	3.2V DC for pulse signals and 1.2V DC for coil pick-up.
Note	This is not a real sensor supply. Only suitable for sensors with a very low power consumption like coils (sine wave) and reed-switches.
Type PD	1.2 / 3 / 8.2 / 12 / 24V DC - max. 50mA @ 24V DC.
Type PD-XI	1.2 / 3 / 8.2V DC - max. 7mA @ 8.2V DC and mains power supply voltage (as connected to terminal 1).
Note	In case PD-XI and signal A or U: the sensor supply voltage is according to the power supply voltage connected to terminal 1. Also terminal 2 offers the same voltage.
Type PF / PM	1.2 / 3 / 8.2 / 12 / 24V DC - max. 400mA @ 24V DC.

Terminal connections

Type	Removable plug-in terminal strip. Wire max. 1.5mm ² and 2.5mm ² .
------	---

Data protection

Type	EEPROM backup of all settings. Backup of running totals every minute. Data retention at least 10 years.
Password	Configuration settings can be password protected.

Directives & Standards

EMC	Directive 2014/30/EU, FCC 47 CFR part 15.
Low voltage	Directive 2014/35/EU
RoHS	Directive 2011/65/EU
ATEX / IECEx	Directive 2014/34/EU, IEC 600079-0, IEC 60079-11.
IP & Type	EN 60529 & NEMA 250

Enclosure

General	
Window	Polycarbonate window.
Sealing	Silicone.
Control keys	Three industrial micro-switch keys. UV-resistant silicone keypad.

Aluminum wall / field mount enclosures

General	Die-cast aluminum wall/field mount enclosure IP67 / NEMA Type4X with 2-component UV-resistant coating.
Dimensions	130 x 120 x 75mm (5.12" x 4.72" x 2.95") - W x H x D.
Weight	1100 gr.
Type HA	Cable entry: 2 x PG9 and 1 x M20.
Type HL	Cable entry: 2 x 1/2" NPT.
Type HM	Cable entry: 2 x M16 and 1 x M20.
Type HN	Cable entry: 1 x M20.
Type HO	Cable entry: 2 x M20.
Type HP	Cable entry: 6 x M12.
Type HT	Cable entry: 1 x 1/2" NPT.
Type HU	Cable entry: 3 x 1/2" NPT.
Type HV	Cable entry: 4 x M20.
Type HZ	Cable entry: no holes.

GRP wall / field mount enclosures



General	GRP wall/field mount enclosure IP67 / NEMA Type4X, UV-resistant and flame retardant.
Dimensions	130 x 120 x 75mm (5.12" x 4.72" x 2.95") - W x H x D.
Weight	600 gr.
Type HD	Cable entry: no holes.
Type HE	Cable entry: 2 x Ø 16mm and 1 x Ø 20mm.
Type HF	Cable entry: 1 x Ø 22mm (7/8").
Type HG	Cable entry: 2 x Ø 20mm.
Type HH	Cable entry: 6 x Ø 12mm.
Type HJ	Cable entry: 3 x Ø 22mm (7/8").
Type HK	Flat bottom, cable entry: no holes.

Panel mount enclosures

Dimensions	130 x 120 x 60mm (5.12" x 4.72" x 2.36") - W x H x D.
Panel cut-out	115 x 98mm (4.53" x 3.86") L x H.
Type HB	Die-cast aluminum panel mount enclosure IP65 / NEMA Type4X.
Weight	600 gr.
Type HC	GRP panel mount enclosure IP65 / NEMA Type4X, UV-resistant and flame retardant.
Weight	450 gr.

Hazardous area

Intrinsically Safe (Type XI)

ATEX certification	 II 1 G Ex ia IIB/IIC T4 Ga.
IECEX certification	 Ex ia IIC/IIB T4 Ga.
Ambient Ta	-40°C to +70°C (-40°F to +158°F).

Explosion proof (Type XF)

ATEX certification	 II 2 G / Ex d IIB T5 Gb. II 2 D / Ex t IIIB T100 °C Db..
Dimensions	300 x 250 x 200mm (11.8" x 9.9" x 7.9") L x H x D.
Weight	Appr. 15kg.

Signal inputs

Flowmeter

Type P	Coil / sine wave (HI: 20mVpp or LO: 80mVpp - sensitivity selectable), NPN/PNP, open collector, reed-switch, Namur, active pulse signals 8 - 12 and 24V DC.
Frequency	Minimum 0Hz - maximum 7kHz for total and flow rate. Maximum frequency depends on signal type and internal low-pass filter. E.g. reed switch with low-pass filter: max. frequency 120Hz.
K-Factor	0.000010 - 9,999,999 with variable decimal position.
Low-pass filter	Available for all pulse signals.
Option ZF	coil sensitivity 10mVpp.
Type A	(0)4 - 20mA. Analog input signal can be scaled to any desired range within 0 - 20mA.
Type U	0 - 10V DC. Analog input signal can be scaled to any desired range within 0 - 10V DC.
Accuracy	Resolution: 14 bit. Error < 0.025mA / ± 0.125% FS. Low level cut-off programmable.
Span	0.000010 - 9,999,999 with variable decimal position.
Update time	Four times per second.
Voltage drop	Type A: 2.5V @ 20mA.
Load impedance	Type U: 3kOhm.
Relationship	Linear and square root calculation.
Note	For signal type A and U: external power to sensor is required; e.g. type PD.

Signal outputs

Analog output

Function	Transmitting flow rate.
Accuracy	10 bit. Error < 0.05%. Analog output signal can be scaled to any desired range.
Update time	Eight times per second.
Type AA	Active 4 - 20mA output (requires PD, PF, PM or PX).
Type AB	Active 0 - 20mA output (requires PD, PF, PM or PX).
Type AF	Passive floating 4 - 20mA output for Intrinsically Safe applications (requires XI + PD or PX).
Type AI	Passive galvanically isolated 4 - 20mA output - also available for battery powered models.
Type AP	Passive 4 - 20mA output - not isolated. Unit will be loop powered.
Type AU	Active 0 - 10V DC output (requires PD, PF, PM or PX).

Communication option

Function	Reading display information, reading / writing all configuration settings.
Protocol	Modbus ASCII / RTU.
Speed	1200 - 2400 - 4800 - 9600 baud.
Addressing	Maximum 255 addresses.
Type CB	RS232
Type CH	RS485 2-wire
Type CI	RS485 4-wire
Type CT	TTL Intrinsically Safe.

Digital outputs

Function	All outputs are user defined: pulse output or low, low-low, high, high-high or all alarms output.
Frequency	Max. 500Hz. Pulse length user definable between 0.001 second up to 9.999 seconds.
Type OA	Three active 24V DC transistor outputs (PNP); max. 50mA per output (requires PD, PF, PM or PX).
Type OR	Two electro-mechanical relay outputs - isolated (N.O.) - max. switch power 230V AC - 0.5A (requires PF or PM) and one transistor output OA or OT.
Type OS	Four electro-mechanical relay outputs - isolated N.O.); max. switch power 230V AC - 0.5A per relay (requires AP + PD with 24V AC / DC).
Type OT	Three passive transistor outputs (NPN) - not isolated. Max. 50V DC - 300mA per output.
Note	Intrinsically Safe applications: only two transistor outputs type OT available.

Operational

Operator functions

Displayed functions	<ul style="list-style-type: none">• Flow rate and / or total.• Total and accumulated total.• Low-low alarm value.• Low alarm value.• High alarm value.• High-high alarm value.• Total can be reset to zero by pressing the CLEAR-key twice.• Alarm values can be set (or only displayed).
---------------------	--

Total

Digits	7 digits.
Units	L, m ³ , GAL, USGAL, kg, lb, bbl, no unit.
Decimals	0 - 1 - 2 or 3.
Note	Total can be reset to zero.

Accumulated total

Digits	11 digits.
Units / decimals	According to selection for total.
Note	Can not be reset to zero.

Flow rate

Digits	7 digits.
Units	mL, L, m ³ , Gallons, kg, Ton, lb, bl, cf, RND, ft ³ , scf, Nm ³ , NL, ical - no units.
Decimals	0 - 1 - 2 or 3.
Time units	/sec - /min - /hr - /day.

Alarm values

Digits	7 digits.
Units	According to selection for flow rate.
Decimals	According to selection for flow rate.
Time units	According to selection for flow rate.
Type of alarm	Low, high, low-low or high-high flow rate alarm. Includes delay time alarm and configurable alarm outputs.

Additional input

Function	<ul style="list-style-type: none">• Terminal input to reset total remotely.• If this terminal input is closed, the "clear total"-function is disabled.
Type IB	Internally pulled-up switch contact - NPN.
Duration	Minimum pulse duration 100msec.

Ordering information

Standard configuration: F113-P-AP-CX-HC-IX-OT-PX-XX-ZX.

Ordering information:	F113	-	-A	-C	-H	-I	-O	-P	-X	-Z
Flowmeter input signal										
A	⊗ (0)4 - 20mA input.									
P	⊗ Pulse input: coil, npn, pnp, namur, reed-switch.									
U	⊗ 0 - 10V DC input.									
Analog output signal										
AA	Active 4 - 20mA output - requires PD, PF, PM or PX.									
AB	Active 0 - 20mA output - requires PD, PF, PM or PX.									
AF	⊗ I.S. floating 4 - 20mA output - requires XI + PD or PX.									
AI	Isolated 4 - 20mA output.									
AP	⊗ Passive 4 - 20mA output, loop powered unit.									
AU	Active 0 - 10V DC output - requires PD, PF, PM or PX.									
Communication										
CB	Communication RS232 - Modbus ASCII / RTU.									
CH	Communication RS485 - 2-wire - Modbus ASCII / RTU.									
CI	Communication RS485 - 4-wire - Modbus ASCII / RTU.									
CT	⊗ Intrinsically Safe TTL - Modbus ASCII / RTU.									
CX	⊗ No communication.									
Panel mount enclosures - IP65 / NEMA Type4X										
HB	⊗ Aluminum enclosure.									
HC	⊗ GRP enclosure.									
GRP field / wall mount enclosures - IP67 / NEMA Type4X										
HD	⊗ Cable entry: no holes.									
HE	⊗ Cable entry: 2 x Ø 16mm & 1 x Ø 20mm.									
HF	⊗ Cable entry: 1 x Ø 22mm (7/8").									
HG	⊗ Cable entry: 2 x Ø 20mm.									
HH	⊗ Cable entry: 6 x Ø 12mm.									
HJ	⊗ Cable entry: 3 x Ø 22mm (7/8").									
HK	⊗ Flat bottom, cable entry: no holes.									
Aluminum field / wall mount enclosures - IP67 / NEMA Type4X										
HA	⊗ Cable entry: 2 x PG9 + 1 x M20.									
HL	⊗ Cable entry: 2 x 1/2"NPT.									
HM	⊗ Cable entry: 2 x M16 + 1 x M20.									
HN	⊗ Cable entry: 1 x M20.									
HO	⊗ Cable entry: 2 x M20.									
HP	⊗ Cable entry: 6 x M12.									
HT	⊗ Cable entry: 1 x 1/2"NPT.									
HU	⊗ Cable entry: 3 x 1/2"NPT.									
HV	⊗ Cable entry: 4 x M20.									
HZ	⊗ Cable entry: no holes.									
Additional input signal										
IB	⊗ Remote control input to reset total or to lock the "clear total" button.									
IX	⊗ No additional input.									
Digital output signals										
OA	Three active transistor outputs - requires PD, PF, PM or PX									
OR	Two mechanical relay outputs + one OA or OT - requires PF or PM.									
OS	Four mechanical relay outputs - requires AP + PD.									
OT	⊗ Three passive transistor outputs - standard configuration.									
Power requirements										
PD	⊗ 8 - 24V AC/DC + sensor supply - with XI: 16 - 30V DC.									
PF	24V AC/DC + sensor supply.									
PL	Input loop powered from sensor signal type "A" - requires AI and OT (not XI).									
PM	115 - 230V AC + sensor supply.									
PX	⊗ Basic power supply 8 - 30V DC (no real sensor supply).									
Additional battery supply (optional)										
PB	Lithium battery powered - requires PD, PL or PX.									
PC	⊗ Lithium battery powered - Intrinsically Safe - requires XI, and PD or PX.									
Hazardous area										
XI	⊗ Intrinsically Safe, according ATEX and IECEx.									
XF	EExd enclosure - 3 keys.									
XX	Safe area only.									
Other options										
ZB	Backlight.									
ZF	⊗ Coil input 10mVpp.									
ZX	⊗ No options.									

The bold marked text contains the standard configuration.

⊗ Available Intrinsically Safe.

Specifications are subject to change without notice.



Quality
ISO 9001

www.dekra-seal.com

Fluidwell bv

P.O. Box 6
5460 AA - Veghel - The Netherlands
Telephone: +31 (0)413 343 786
Telefax: +31 (0)413 363 443
email: displays@fluidwell.com
Internet: www.fluidwell.com

