

DIFFERENTIAL / SUM FLOWCOMPUTER

WITH ANALOG AND PULSE SIGNAL OUTPUTS



Advantages

- Robust IP67 (NEMA Type4X) field enclosure. It is so rugged, **you can even stand on it!**
- Intrinsically Safe available - ATEX and IECEx approval for gas and dust applications.
- Programming can be done by your own crew, with the sensible menu-driven structure, saving cost and irritation. **Know one, know them all!**
- Very diverse mounting possibilities: walls, pipes, panels or directly onto outdoor sensors!

Features

- Calculates differential flow rate (consumption) total and accumulated total of flow A and B or the sum.
- Precautions for pulsating flows and very low consumption readings.
- 7 digit resettable total, 11 digit accumulated total.
- Large 17mm (0.67") digits for flow rate or total.
- Explosion/flame proof available.
- Full Modbus communication RS232/485/TTL.
- Loop or battery powered, 8 - 24V AC/DC or 115 - 230V AC power supply.
- Sensor supply 3 / 8.2 / 12 / 24V DC.
- LED backlight option.

Signal output

- (o)4 - 20mA / o - 10V DC according to differential / sum flow rate.
- Scaled pulse output according to differential / sum accumulated total.
- Negative total value indication.

Signal input

Flow

- Ability to process all types of flow meter signals: Reed-switch, NAMUR, NPN/PNP pulse, Sine wave (coil), Active pulse signals, (o)4 - 20mA, o - 10V DC.

Applications

- The F-Series is your first and safest choice for field mount indicators in safe and hazardous area applications. Especially in harsh weather conditions like rain, snow, salty atmospheres and temperatures between -40°C up to +80°C (-40°F up to 176°F).
- Fuel consumption calculation for diesel engines on board of ships or locomotives. Sum function: where flows are split-up in two pipe-lines and total flow has to be calculated. More advanced model: F127. For DIN panel mount indicators, check our [D-Series](#).

General information

Introduction

The flowcomputer Model F116 has been developed to calculate differential or total volume. Typical applications are the measurement of fuel consumption or the calculation of total flow (sum) if - for costs reasons - two low cost flow meters can be used instead of one expensive flow meter. The usual difficulties encountered in such applications include: pulsating flows, very low consumption readings, vibration and high ambient temperatures. These are all well catered for in the design and operation of the F116.

Display

The display has large 17mm (0.67") and 8mm (0.31") digits which can be set to show flow rate and total. On-screen engineering units are easily configured from a comprehensive menu. The accumulated total can register up to 11 digits and is backed-up in EEPROM memory every minute.

Configuration

All configuration settings are accessed via a simple operator menu which can be password protected. Each setting is clearly indicated with an alphanumerical description, which avoids confusing abbreviations. Once familiar with one F-series product, you will be able to program all models in the series without a manual. All settings are safely stored in EEPROM memory in the event of sudden power loss.

Analog output signal

The calculated flow rate is re-transmitted with the (o)4 - 20mA or 0 - 10V DC output signal. The output signal is updated eight times per second with a filter function being available to smoothen out the signal if desired.

The output value is user defined in relation to the flow rate, e.g. 4mA equals to 15L/Hr and 20mA equals to 2000L/Hr. The output signal can be passive, active or isolated where the passive output type will loop power the F116 as well.

Pulse output

The scaleable pulse output, reflects the count on the accumulated display. The pulse length is user defined and the maximum output frequency is 500Hz. The second output will be switched in case

the total is counting down (negative consumption). The output signal can be a passive NPN, active PNP or an isolated electro-mechanical relay.

Signal input

The F116 accepts most pulse and analog input signals for volumetric flow or mass flow measurement. The input signal type can be selected by the user in the configuration menu without having to adjust any sensitive mechanical dip-switches or jumpers.

Communication

All process data and settings can be read and modified manually or through the Modbus communication link (RS232 / RS485).

Full Modbus functionality remains available for the Intrinsically Safe version (TTL).

Hazardous areas

This model has been ATEX and IECEx certified Intrinsically Safe for gas and dust applications, with an allowed ambient temperature of -40°C to +70°C (-40°F to +158°F). A flame proof Ex d enclosure with ATEX certification is also available.

Enclosures

Various types of enclosures can be selected, all ATEX and IECEx approved. As standard the F116 is supplied in an GRP panel mount enclosure. Most popular is our rugged aluminum field mount enclosure with IP67 / NEMA Type4X rating. Both European or U.S. cable gland entry threads are available.

Overview application F116

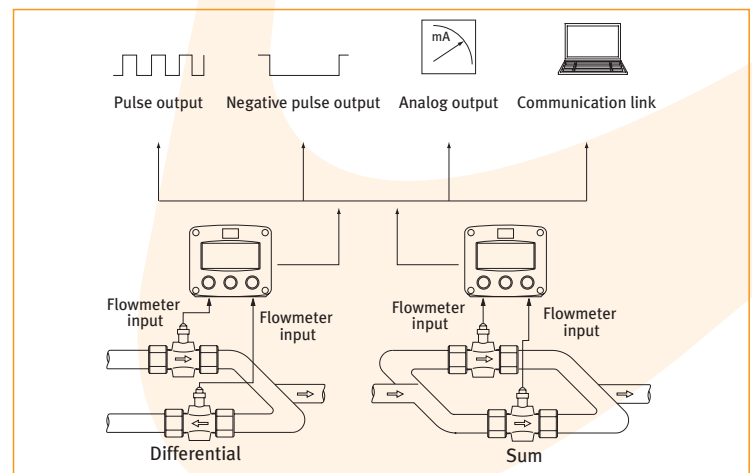

Dimensions enclosures

Aluminum & GRP panel mount enclosure

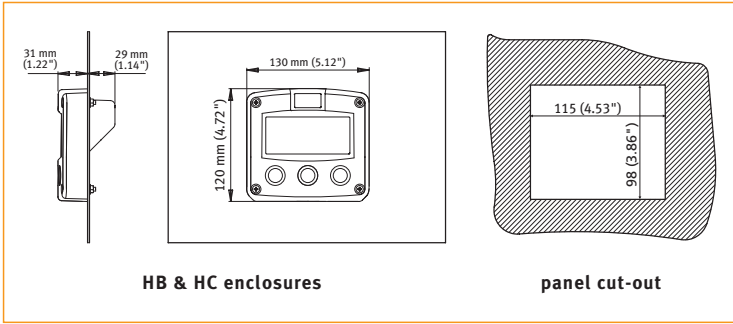

HB & HC enclosures

panel cut-out

Aluminum & GRP field / wall mount enclosures

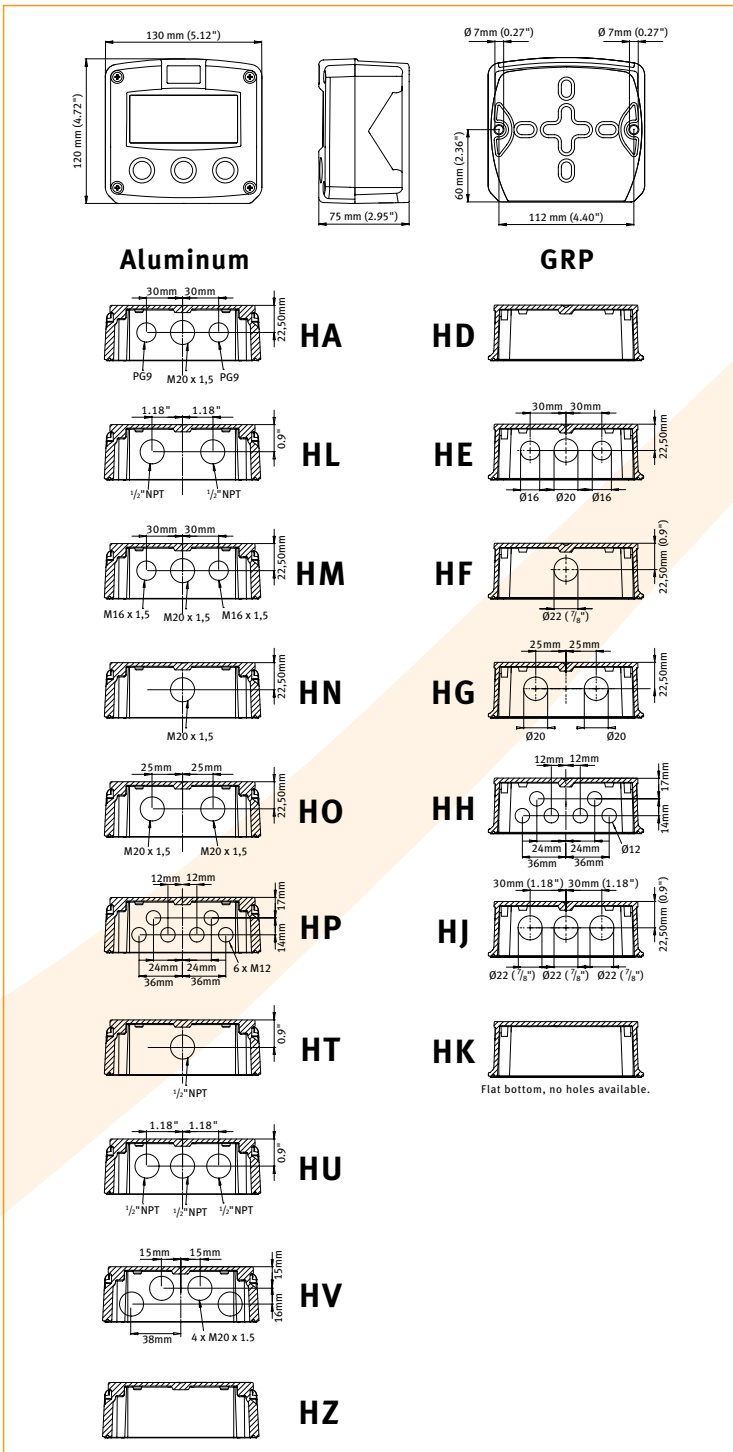

Aluminum

GRP

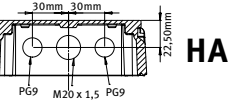

HA

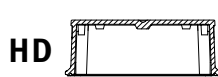

HD

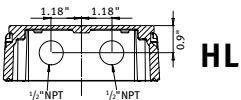

HL

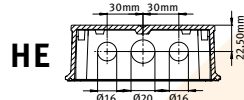

HE

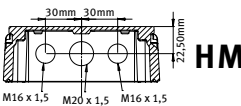

HM

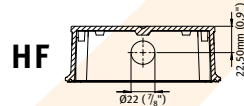

HF

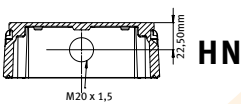

HN

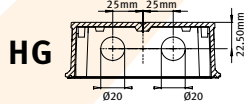

HG

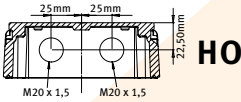

HO

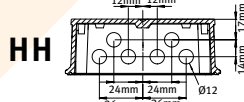

HH

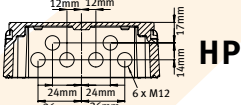

HP

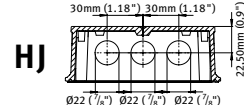

HJ

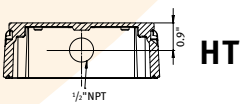

HT

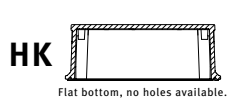

HK

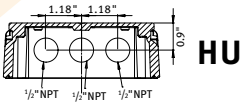

HU

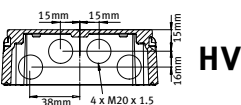

HV

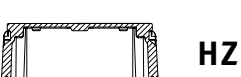

HZ

Terminal connections

COMMUNICATION	26	27	28	29	30	31
CB: RS232	⊥	DTR +12V	RXD	TXD		
CH: RS485 - 2 wire	⊥		A	B		
CI: RS485 - 4 wire	⊥		A	B	Y	Z
CT: TTL, Intrinsically Safe	⊥		DTR +12V	RXD	TXD	
	15	16	17	18	19	20
	21	22	23	24	25	
FLOWMETER INPUT B	12	13	14			
P: coil	⊥	~	~			
P: read switch / NPN	⊥	+	+			
P: PNP	⊥	-	-			
P: namur	⊥	-	-			
P: active signal	⊥	+	+			
A: (0)4 - 20mA	⊥	+	+			
U: 0 - 10V	⊥	+	+			
FLOWMETER INPUT A	09	10	11			
P: coil	⊥	~	~			
P: read switch / NPN	⊥	+	+			
P: PNP	⊥	-	-			
P: namur	⊥	-	-			
P: active signal	⊥	+	+			
A: (0)4 - 20mA	⊥	+	+			
U: 0 - 10V	⊥	+	+			
ANALOG OUTPUT	07	08				
AO: 4 - 20mA	⊥	+	+			
AI: 0 - 20mA	⊥	-	-			
AP: 4 - 20mA	⊥	+	+			
AI: 4 - 20mA	⊥	-	-			
U: 0 - 10V	⊥	+	+			
U: L	⊥	+	+			
PULSE OUTPUT	05	06				
OA: active 24V DC	⊥	+	+			
OT: passive trans.	⊥	-	-			
OR: mech. relay	⊥	+	+			
NEGATIVE PULSE OUTPUT	03	04				
OA: active 24V DC	⊥	+	+			
OT: passive trans.	⊥	-	-			
OR: mech. relay	⊥	+	+			
POWER REQUIREMENTS	00	01	02			
PD: 8 - 24V AC	⊥	~	~			
PD: 8 - 24V DC	⊥	+	+			
PD: XT: 6 - 30V DC	⊥	+	+			
PF: 24V AC	⊥	~	~			
PF: 24V DC	⊥	+	+			
PM: 115 - 230V AC	⊥	~	~			
PX: 8 - 30V DC	⊥	+	+			
ZB: Backlight: 12 - 24V DC	⊥	+	+			
AP: 8 - 30V DC	⊥	+	+			
Output loop powered	⊥	+	+			

Display example - 90 x 40mm (3.5" x 1.6")

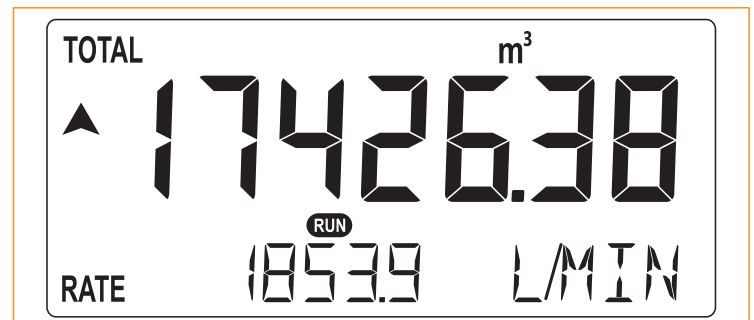

Typical wiring diagram F116-P-(AP)-CH-(OT)-PB-(PX)

Typical wiring diagram F116-P-AP-CH-OT-PX

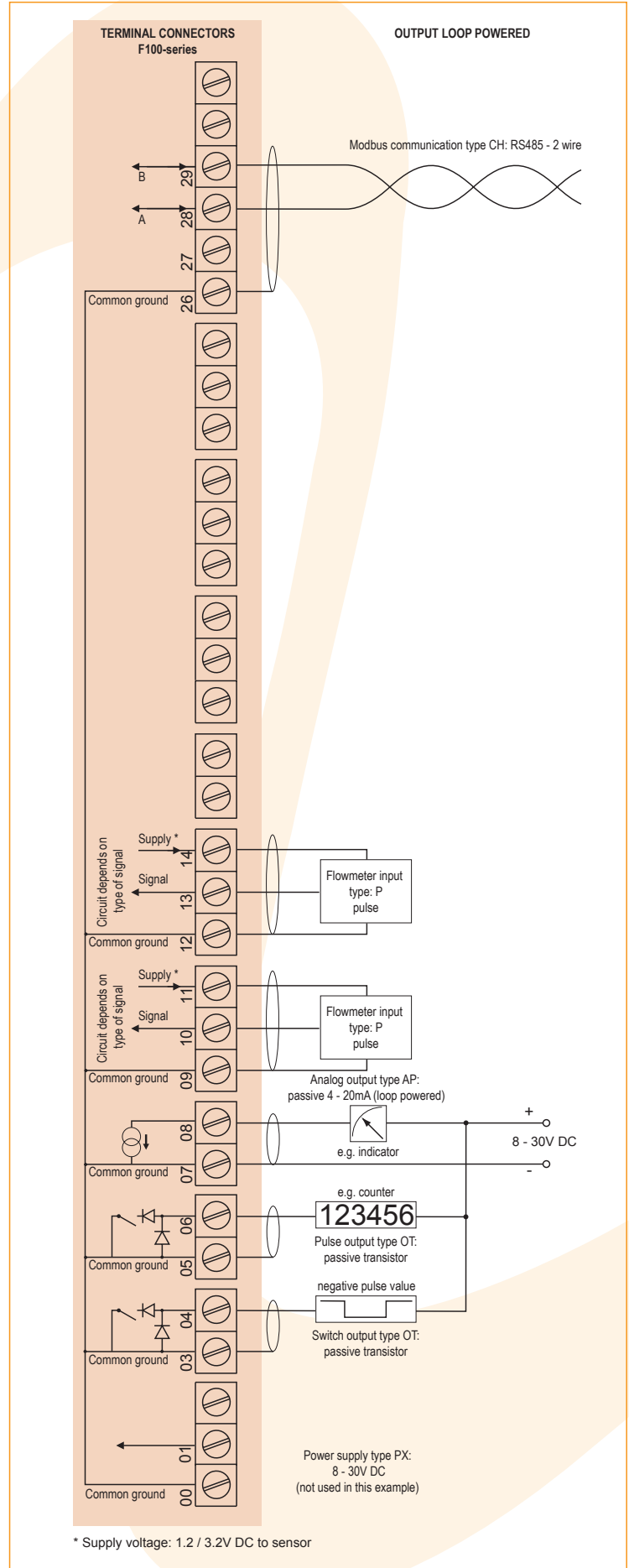
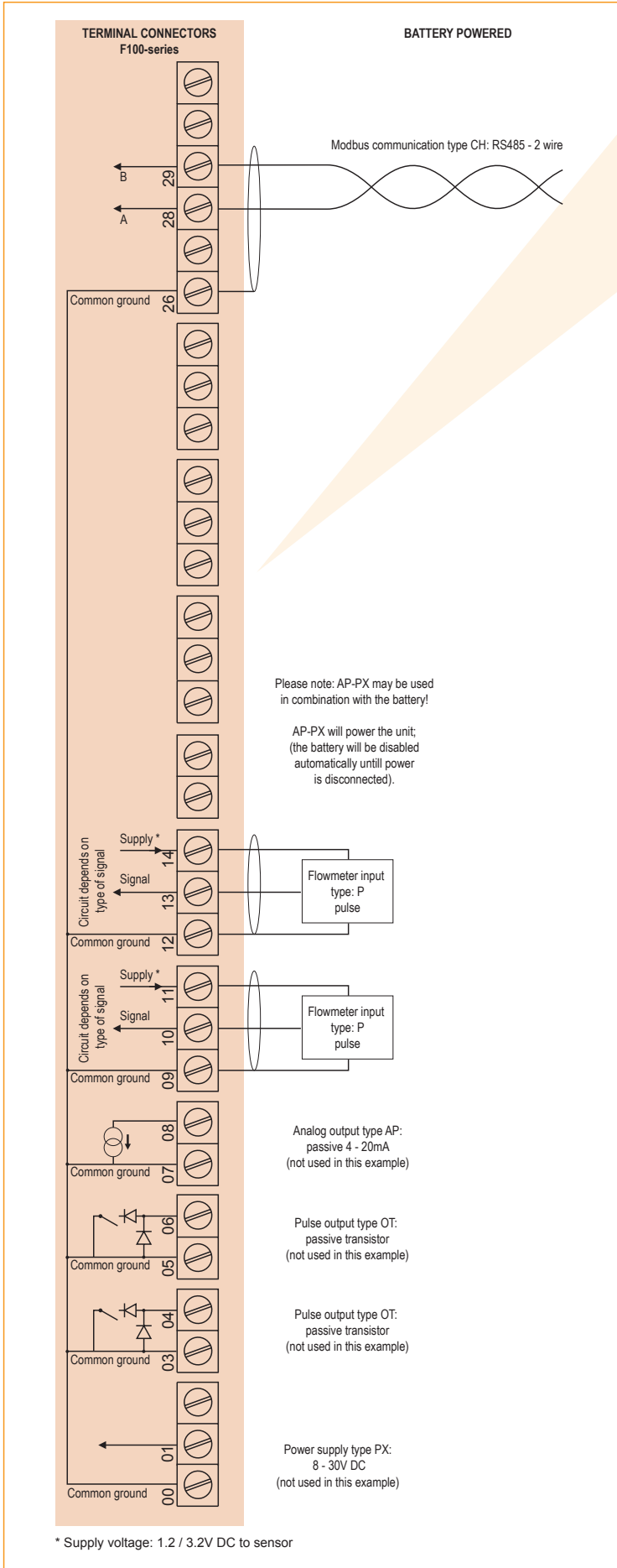

Typical wiring diagram F116-A-AA-CB-OA-PD

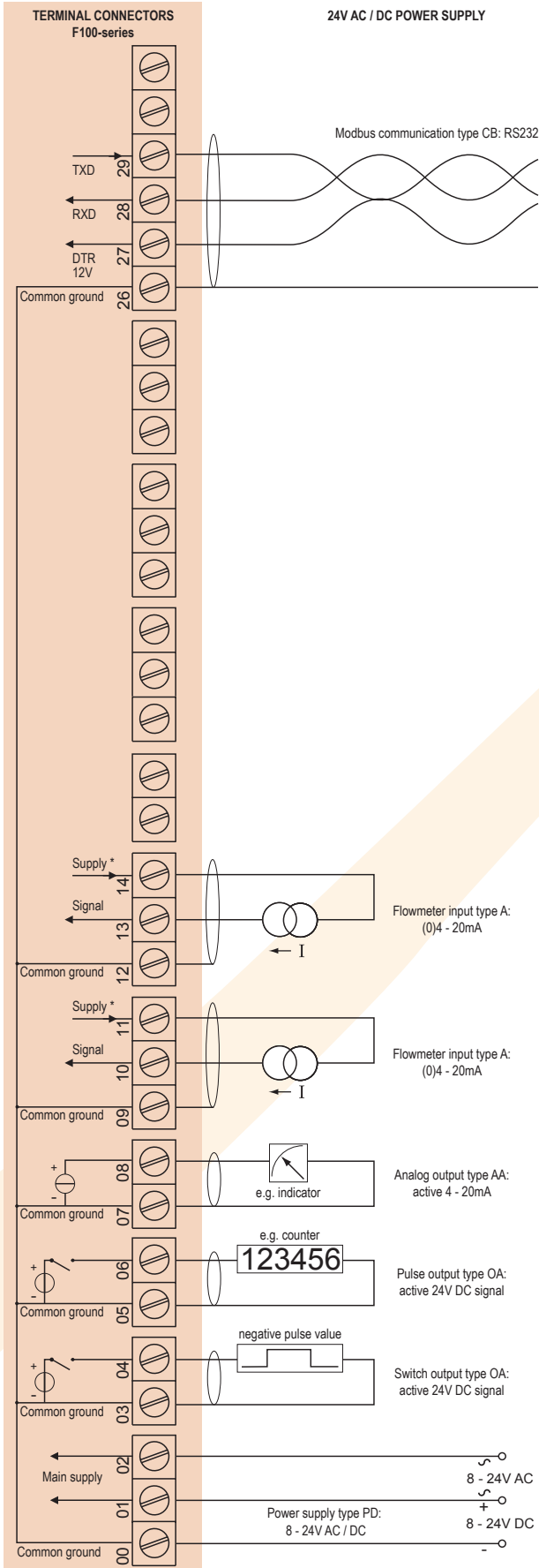

* Supply voltage: 3.2 / 8.2 / 12 / 24V DC to sensor

Typical wiring diagram F116-A-AI-CI-OR-PM

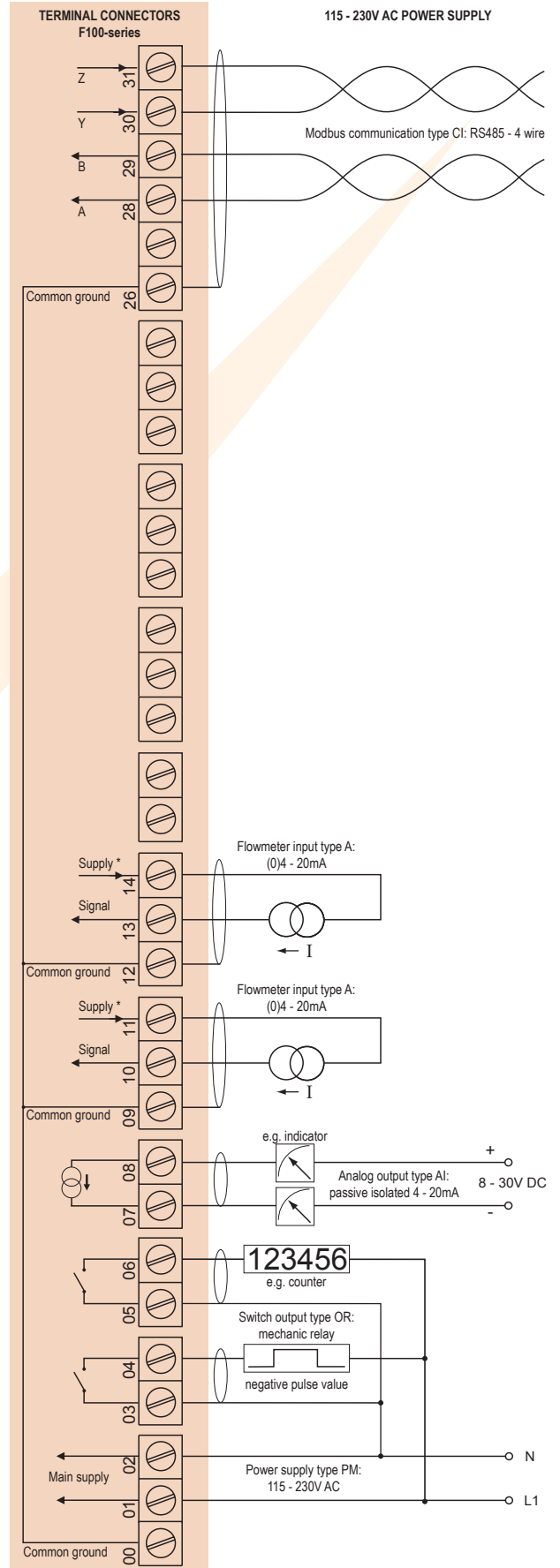

* Supply voltage: 3.2 / 8.2 / 12 / 24V DC to sensor

Hazardous area applications

The F116-XI has been certified according ATEX and IECEx by DEKRA for use in Intrinsically Safe applications with an ambient temperature of -40°C to +70°C (-40°F to +158°F).

- The ATEX markings for gas and dust applications are:

II 1 G Ex ia IIB/IIC T4 Ga
II 1 D Ex ia IIIC T100 °C Da.

- The IECEx markings for gas and dust applications are: **Ex ia IIC/IIB T4 Ga** and **Ex ia IIIC T100 °C Da.**

Besides the two I.S. power supplies for the pulse outputs, it is allowed to connect up to four I.S. power supplies in IIB/IIC applications or one in IIC applications. Consult the certificate for the maximum input and output values of the circuits. Full functionality of the F116 remains available, including 4 - 20mA output, pulse output and Modbus communication (type CT). Power supply type PD-XI offers a 8.2V sensor supply e.g. for two Namur sensors. An ATEX approved flame proof Ex d enclosure is available as well. Please contact your supplier for further details.

Certificate of conformity KEMA 03ATEX1074 X
• IECEx DEK 11.0042X

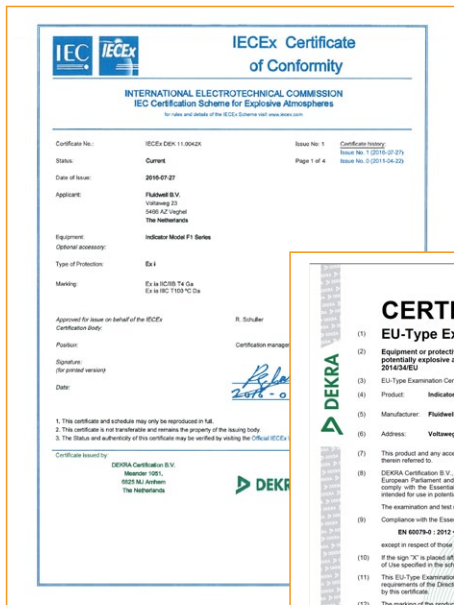

Configuration example IIB / IIC and IIC F116-P-(AP)-(CT)-(OT)-PC-XI - Battery powered unit

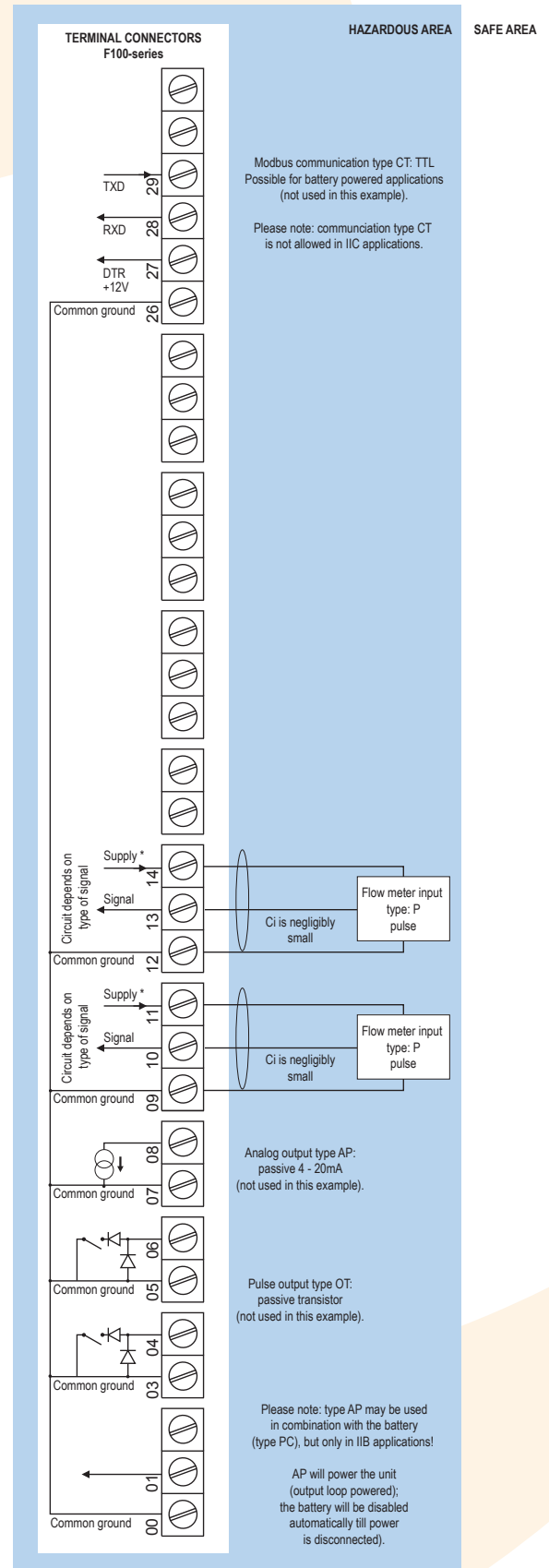

Configuration example IIB / IIIC and IIC - F116-P-AP-(CT)-OT-(PX)-XI - Output loop powered

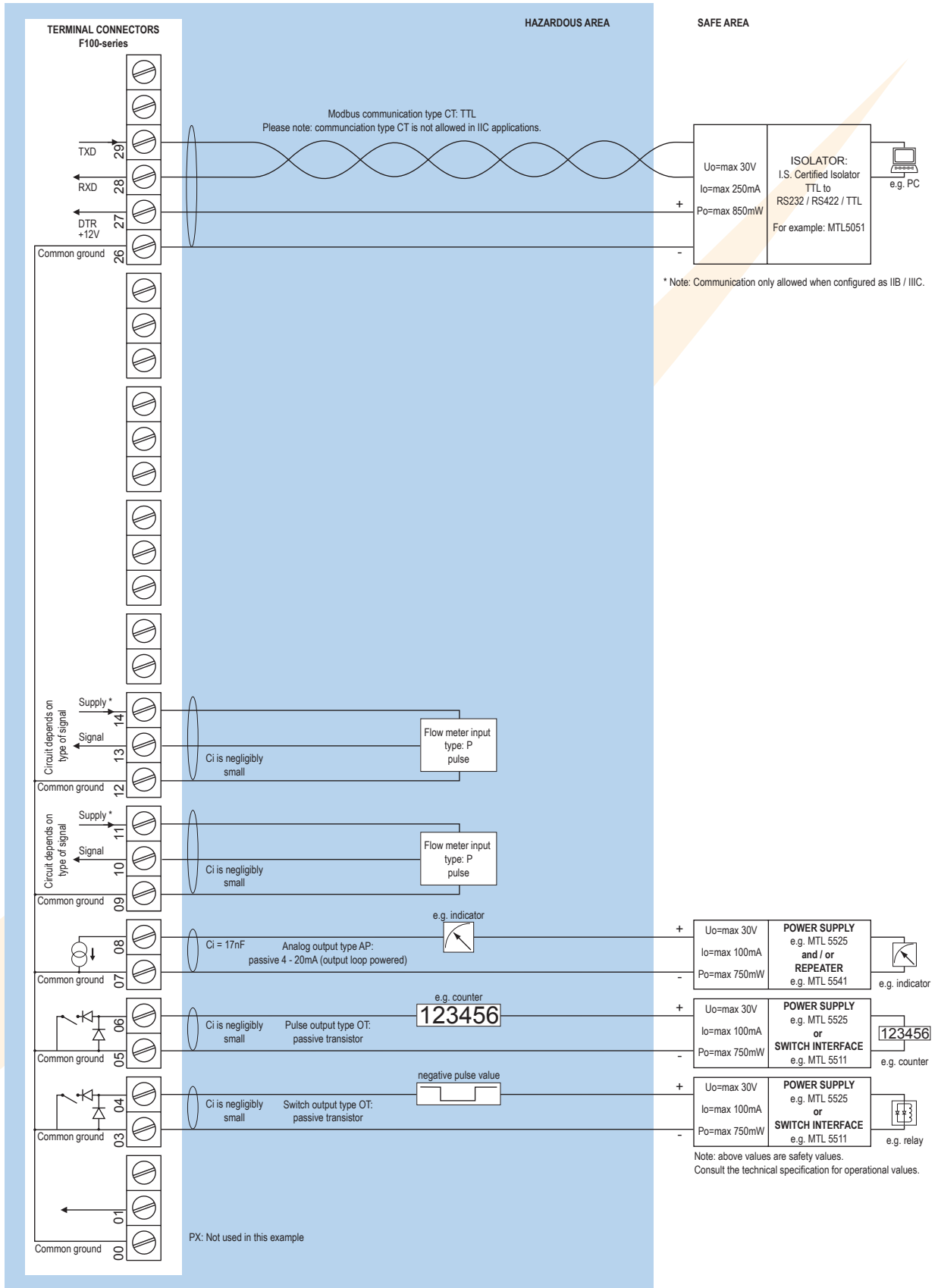

* Note sensor supply voltage: 1.2V DC for coil sensors or 3.2V DC for other pulse sensors.

Configuration example IIB / IIC and IIC - F116-A-AF-(CT)-OT-PD-XI - Power supply 16 - 30V DC

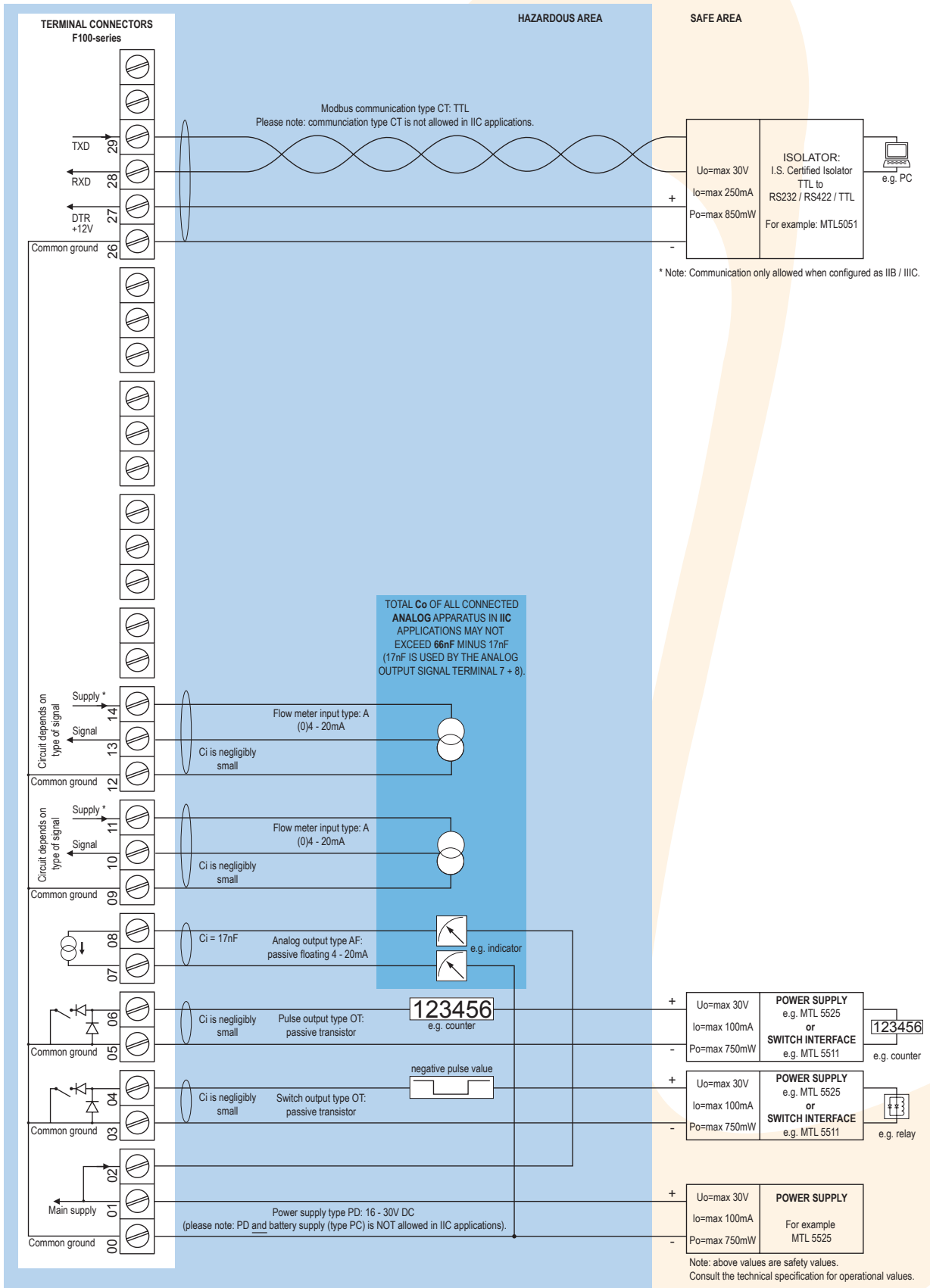

* Note power supply type PD: the supply voltage to pulse sensors is maximum 8.7V (U_o=max 8.7V I_o=max 25mA P_o=max 150mW) and to analog sensors as connected to terminal 1 (internally linked).

Configuration example IIB / IIIC - F116-A-AF-CT-OT-(PC)-(PD)-XI - Power supply 16 - 30V DC or battery powered

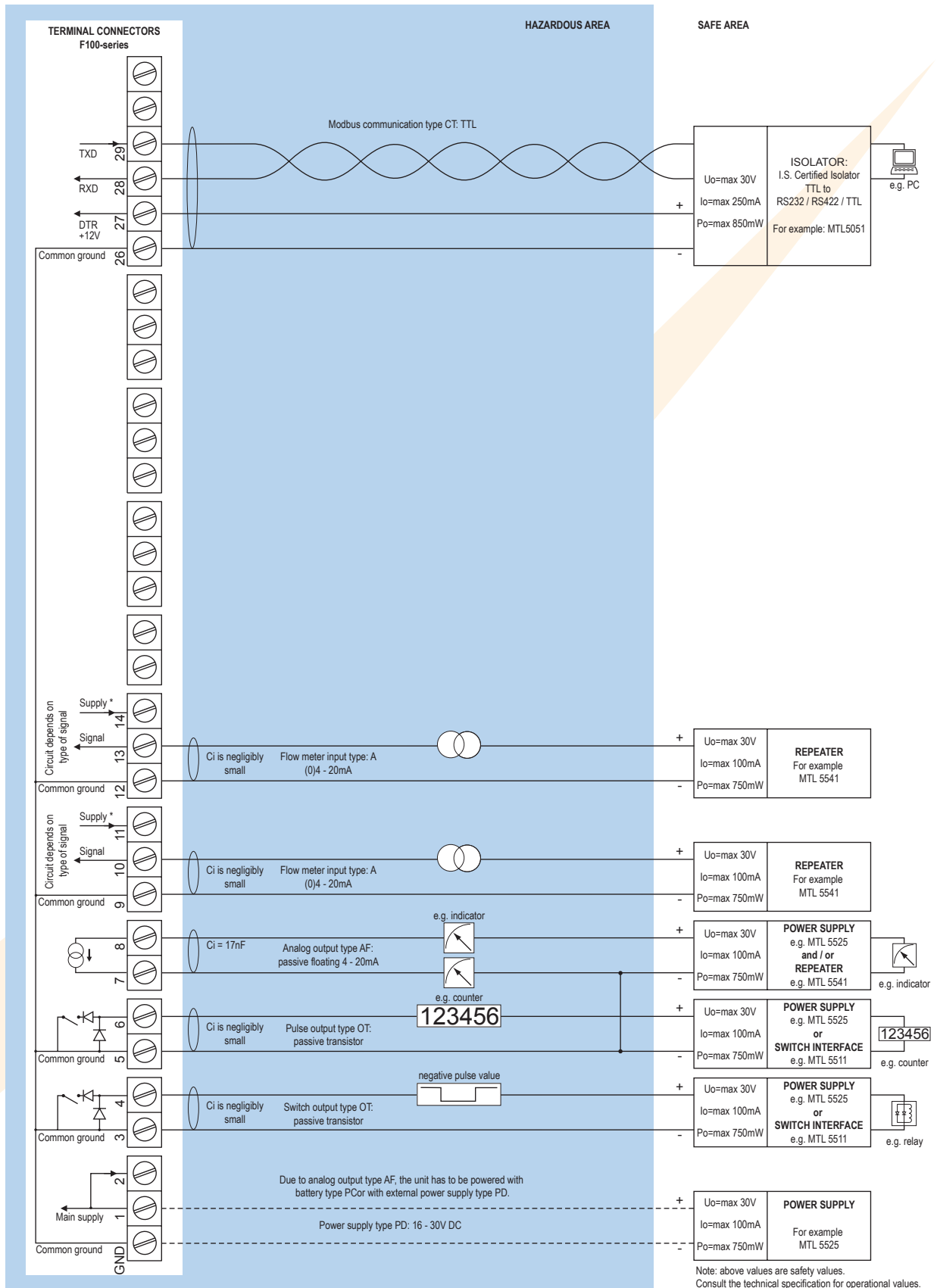

* Note power supply type PD: the supply voltage to pulse sensors is maximum 8.7V ($U_o = \max 8.7V$ $I_o = \max 25mA$ $P_o = \max 150mW$) and to analog sensors as connected to terminal 1 (internally linked).

Technical specification

General

Display	
Type	High intensity reflective numeric and alphanumeric LCD, UV-resistant.
Dimensions	90 x 40mm (3.5" x 1.6").
Digits	Seven 17mm (0.67") and eleven 8mm (0.31") digits. Various symbols and measuring units.
Refresh rate	User definable: fast, 1sec, 3sec, 15sec, 30sec, off.
Option ZB	Transflective LCD with white LED-backlight. Good readings in full sunlight and darkness.
Note ZB	Only available for safe area applications.

Ambient temperature

Safe areas	-40°C to +80°C (-40°F to +176°F).
Intrinsically Safe	-40°C to +70°C (-40°F to +158°F).

Power requirements

Type AP	Analog output loop powerd, 8 - 30V DC. Power consumption max 0.5 Watt.
Type PB	Long life Lithium battery - life-time depends upon settings and configuration - up to 5 years. (requires PD or PX)
Type PC	Intrinsically Safe long life lithium battery - life-time depends upon settings and configuration - up to 5 years. (requires XI and PD or PX)
Type PD	8 - 24V AC / DC ± 10%. Power consumption max. 10 Watt. Intrinsically Safe: 16 - 30V DC; power consumption max. 0.75 Watt.
Type PF	24V AC / DC ± 10%. Power consumption max. 15 Watt.
Type PM	115 - 230V AC ± 10%. Power consumption max. 15 Watt.
Type PX	8 - 30V DC. Power consumption max. 0.5 Watt.
Type ZB	12 - 24V DC ± 10%. Power consumption max. 1 Watt.
Note PB/PF/PM	Not available Intrinsically Safe.
Note PF/PM	The total consumption of the sensors and outputs may not exceed 400mA @ 24V.
Note	For Intrinsically Safe applications, consult the safety values in the certificate.

Sensor excitation

Type PB/PC/PX	3V DC for pulse signals and 1.2V DC for coil pick-up.
Note	This is not a real sensor supply. Only suitable for sensors with a very low power consumption like coils (sine wave) and reed-switches.
Type PD	1.2 / 3 / 8.2 / 12 / 24V DC - max. 50mA @ 24V DC.
Type PD-XI	1.2 / 3 / 8.2V DC - max. 7mA @ 8.2V DC and mains power supply voltage (as connected to terminal 1).
Note	In case PD-XI and signal A or U: the sensor supply voltage is according to the power supply voltage connected to terminal 1. Also terminal 2 offers the same voltage.
Type PF / PM	1.2 / 3 / 8.2 / 12 / 24V DC - max. 400mA @ 24V DC.

Terminal connections

Type	Removable plug-in terminal strip. Wire max. 1.5mm ² and 2.5mm ² .
------	---

Data protection

Type	EEPROM backup of all settings. Backup of running totals every minute. Data retention at least 10 years.
Password	Configuration settings can be password protected.

EMC	Directive 2014/30/EU, FCC 47 CFR part 15.
Low voltage	Directive 2014/35/EU
RoHS	Directive 2011/65/EU
ATEX / IECEx	Directive 2014/34/EU, IEC 600079-0, IEC 60079-11.
IP & NEMA	EN 60529 & NEMA 250

Enclosure

General	
Window	Polycarbonate window.
Sealing	Silicone.
Control keys	Three industrial micro-switch keys. UV-resistant silicone keypad.

Aluminum wall / field mount enclosures

General	Die-cast aluminum wall/field mount enclosure IP67 / NEMA Type4X with 2-component UV-resistant coating.
Dimensions	130 x 120 x 75mm (5.12" x 4.72" x 2.95") - W x H x D.
Weight	1100 gr.
Type HA	Cable entry: 2 x PG9 and 1 x M20.
Type HL	Cable entry: 2 x 1/2" NPT.
Type HM	Cable entry: 2 x M16 and 1 x M20.
Type HN	Cable entry: 1 x M20.
Type HO	Cable entry: 2 x M20.
Type HP	Cable entry: 6 x M12.
Type HT	Cable entry: 1 x 1/2" NPT.
Type HU	Cable entry: 3 x 1/2" NPT.
Type HV	Cable entry: 4 x M20.
Type HZ	Cable entry: no holes.

GRP wall / field mount enclosures

General	GRP wall/field mount enclosure IP67 / NEMA Type4X, UV-resistant and flame retardant.
Dimensions	130 x 120 x 75mm (5.12" x 4.72" x 2.95") - W x H x D.
Weight	600 gr.
Type HD	Cable entry: no holes.
Type HE	Cable entry: 2 x Ø 16mm and 1 x Ø 20mm.
Type HF	Cable entry: 1 x Ø 22mm (7/8").
Type HG	Cable entry: 2 x Ø 20mm.
Type HH	Cable entry: 6 x Ø 12mm.
Type HJ	Cable entry: 3 x Ø 22mm (7/8").
Type HK	Flat bottom, cable entry: no holes.

Panel mount enclosures

Dimensions	130 x 120 x 60mm (5.12" x 4.72" x 2.36") - W x H x D.
Panel cut-out	115 x 98mm (4.53" x 3.86") L x H.
Type HB	Die-cast aluminum panel mount enclosure IP65 / NEMA Type4X.
Weight	600 gr.
Type HC	GRP panel mount enclosure IP65 / NEMA Type4X, UV-resistant and flame retardant.
Weight	450 gr.

Directives & Standards

Hazardous area

Intrinsically Safe (Type XI)

ATEX certification	 II 1 G Ex ia IIB/IIC T4 Ga. II 1 D Ex ia IIIC T100 °C Da.
IECEX certification	  Ex ia IIC/IIB T4 Ga. Ex ia IIIC T100 °C Da.
Ambient Ta	-40°C to +70°C (-40°F to +158°F).

Explosion proof (Type XF)

ATEX certification	 II 2 G / Ex d IIB T5 Gb. II 2 D / Ex t IIIB T100 °C Db.
Type XF	Dimensions of enclosure: 300 x 250 x 200mm (11.8" x 9.9" x 7.9") L x H x D.
Weight	Appr. 15kg.
Note	IECEX available on request.

Environment

Electromagnetic compatibility	Compliant ref: EN 61326 (1997), EN 61010-1 (1993).
-------------------------------	--

Signal inputs

Flow meter

Type P	Coil / sine wave (minimum 20mVpp or 80mVpp - sensitivity selectable), NPN/PNP, open collector, reed-switch, Namur, active pulse signals 8 - 12 and 24V DC.
Frequency	Minimum 0Hz - maximum 7kHz for total and flow rate. Maximum frequency depends on signal type and internal low-pass filter. E.g. reed switch with low-pass filter: max. frequency 120Hz.
K-Factor	0.000010 - 9,999,999 with variable decimal position.
Low-pass filter	Available for all pulse signals.
Option ZF	coil sensitivity 10mVpp.
Type A	(0)4 - 20mA. Analog input signal can be scaled to any desired range within 0 - 20mA.
Type U	0 - 10V DC. Analog input signal can be scaled to any desired range within 0 - 10V DC.
Accuracy	Resolution: 14 bit. Error < 0.025mA / ± 0.125% FS. Low level cut-off programmable.
Span	0.000010 - 9,999,999 with variable decimal position.
Update time	Four times per second.
Voltage drop	Type A: 2.5V @ 20mA.
Load impedance	Type U: 3kOhm.
Relationship	Linear and square root calculation.
Note	For signal type A and U: external power to sensor is required; e.g. type PD.

Signal outputs

Analog output

Function	Transmitting differential / sum flow rate.
Accuracy	10 bit. Error < 0.05%. Analog output signal can be scaled to any desired range.
Update time	Eight times per second.
Type AA	Active 4 - 20mA output (requires PD, PF, PM or PX).
Type AB	Active 0 - 20mA output (requires PD, PF, PM or PX).
Type AF	Passive floating 4 - 20mA output for Intrinsically Safe applications (requires XI + PD or PX).
Type AI	Passive galvanically isolated 4 - 20mA output - also available for battery powered models.
Type AP	Passive 4 - 20mA output - not isolated. Unit will be loop powered.
Type AU	Active 0 - 10V DC output (requires PD, PF, PM or PX).

Pulse output

Function	Pulse output according to differential or sum accumulated total and indication negative pulse output.
Frequency	Max. 500Hz. Pulse length user definable between 0.001 second up to 9.999 seconds.
Type OA	Two active 24V DC transistor outputs (PNP); max. 50mA per output (requires PD, PF, PM or PX).
Type OR	Two electro-mechanical relay outputs (N.O.) - isolated; max. switch power 230V AC - 0.5A per relay (requires PF or PM).
Type OT	Two passive transistor outputs (NPN) - not isolated. Max. 50V DC - 300mA per output.

Communication option

Function	Reading display information, reading / writing all configuration settings.
Protocol	Modbus RTU.
Speed	1200 - 2400 - 4800 - 9600 baud.
Addressing	Maximum 255 addresses.
Type CB	RS232
Type CH	RS485 2-wire
Type CI	RS485 4-wire
Type CT	TTL Intrinsically Safe.

Operational

Operator functions

Displayed functions	<ul style="list-style-type: none">Differential flow rate (consumption) or the sum of both flow rates.Differential / sum total and accumulated total.Total can be reset to zero by pressing the CLEAR-key twice.
---------------------	---

Total

Digits	7 digits.
Units	L, m ³ , GAL, USGAL, kg, lb, bbl, no unit.
Decimals	0 - 1 - 2 or 3.
Note	Total can be reset to zero.

Accumulated total

Digits	11 digits.
Units / decimals	According to selection for total.
Note	Can not be reset to zero.

Flow rate

Digits	7 digits.
Units	mL, L, m ³ , Gallons, kg, Ton, lb, bl, cf, RND, ft ³ , scf, Nm ³ , NL, igal - no units.
Decimals	0 - 1 - 2 or 3.
Time units	/sec - /min - /hr - /day.

Accessories

Mounting accessories

ACFo2	Stainless steel wall mounting kit.
ACFo5	Stainless steel pipe mounting kit (worm gear clamps not included).
ACFo6	Two stainless steel worm gear clamps Ø 44 - 56mm.
ACFo7	Two stainless steel worm gear clamps Ø 58 - 75mm.
ACFo8	Two stainless steel worm gear clamps Ø 77 - 95mm.
ACFo9	Two stainless steel worm gear clamps Ø 106 - 138mm.
ACF11	Swivel with 25° movement from center axis for direct flowmeter mounting: 1" NPT to 1/2" NPT.



Ordering information

Standard configuration: F116-P-AP-CX-HC-OT-PX-XX-ZX.



Ordering information:

F116 _ -A _ -C _ -H _ -O _ -P _ -X _ -Z _



Flow meter input signal

- A  (o)4 - 20mA input.
- P  Pulse input: coil, npn, pnp, namur, reed-switch.**
- U  0 - 10V DC input.



Analog output signal

- AA Active 4 - 20mA output - requires PD, PF, PM or PX.
- AB Active 0 - 20mA output - requires PD, PF, PM or PX.
- AF  I.S. floating 4 - 20mA output - requires XI + PD or PX.
- AI Isolated 4 - 20mA output.
- AP  Passive 4 - 20mA output, loop powered unit.**
- AU Active 0 - 10V DC output - requires PD, PF, PM or PX.







Communication

- CB Communication RS232 - Modbus RTU.
- CH Communication RS485 - 2wire - Modbus RTU.
- CI Communication RS485 - 4 wire - Modbus RTU.
- CT  Intrinsically Safe TTL - Modbus RTU.
- CX  No communication.**









Panel mount enclosures - IP65 / NEMA Type4X

- HB  Aluminum enclosure.
- HC  GRP enclosure.**

GRP field / wall mount enclosures - IP67 / NEMA Type4X

- HD  Cable entry: no holes.
- HE  Cable entry: 2 x Ø 16mm & 1 x Ø 20mm.
- HF  Cable entry: 1 x Ø 22mm (7/8").
- HG  Cable entry: 2 x Ø 20mm.
- HH  Cable entry: 6 x Ø 12mm.
- HJ  Cable entry: 3 x Ø 22mm (7/8").
- HK  Flat bottom, cable entry: no holes.



Aluminum field / wall mount enclosures - IP67 / NEMA Type4X

- HA  Cable entry: 2 x PG9 + 1 x M20.
- HL  Cable entry: 2 x 1/2" NPT.
- HM  Cable entry: 2 x M16 + 1 x M20.
- HN  Cable entry: 1 x M20.
- HO  Cable entry: 2 x M20.
- HP  Cable entry: 6 x M12.
- HT  Cable entry: 1 x 1/2" NPT.
- HU  Cable entry: 3 x 1/2" NPT.
- HV  Cable entry: 4 x M20.
- HZ  Cable entry: no holes.

Outputs

- OA Two active transistor outputs - requires and PD, PF, PM or PX.
- OR Two mechanical relay outputs - requires PF or PM.
- OT  Two passive transistor outputs - standard configuration.**

Power supply

- PD  8 - 24V AC/DC + sensor supply - with XI: 16 - 30V DC.
- PF 24V AC/DC + sensor supply.
- PM 115 - 230V AC + sensor supply.
- PX  Basic power supply 8 - 30V DC (no real sensor supply).**



Additional battery supply (optional)

- PB Lithium battery powered - requires PD or PX.
- PC  Lithium battery powered - Intrinsically Safe - requires XI, and PD or PX.

Hazardous area

- XI  Intrinsically Safe, according ATEX and IECEx.
- XF Ex d enclosure - 3 keys according ATEX.
- XX Safe area only.**

Other options

- ZB Backlight.
- ZF  Coil input 10mVpp.
- ZX  No options.**

The bold marked text contains the standard configuration.

 Available Intrinsically Safe.

Specifications are subject to change without notice.



Quality
ISO 9001

www.dekra-seal.com

Fluidwell bv

P.O. Box 6
5460 AA - Veghel - The Netherlands
Telephone: +31 (0)413 343 786
Telefax: +31 (0)413 363 443
email: displays@fluidwell.com
Internet: www.fluidwell.com

