

TOTALIZER MONITOR

WITH HIGH / LOW TOTALIZER ALARM AND
ANALOG SIGNAL OUTPUT



Advantages

- Robust IP67 (NEMA Type4X) field enclosure. It is so rugged, **you can even stand on it!**
- Intrinsically Safe available - ATEX and IECEx approval for gas and dust applications.
- Programming can be done by your own crew, with the sensible menu-driven structure, saving cost and irritation. **Know one, know them all!**
- Very diverse mounting possibilities: walls, pipes, panels or directly onto outdoor sensors!

Features

- The desired totalized (preset) quantity can be set by the operator
- Reset totalizer: after stop or time based.
- Totalizer monitoring: two alarm values can be set: low and high totalizer alarm.
- Displays total and preset value or percentage simultaneously.
- Displays clear alarm messages.
- Quadrature input to detect the flow direction.
- Explosion/flame proof available.
- Full Modbus communication RS232/485/TTL.
- Loop or battery powered, 8 - 24V AC/DC or 115 - 230V AC power supply.

Signal output

- One high and one low totalizer alarm output.
- (0)4 - 20mA / 0 - 10V DC related to the totalized quantity or the flow rate.

Signal input

Flow

- Ability to process all types of flowmeter signals: Reed-switch, NAMUR, NPN/PNP pulse, Sine wave (coil), Active pulse signals.

Applications

- The F-Series is your first and safest choice for field mount indicators in safe and hazardous area applications. Especially in harsh weather conditions like rain, snow, salty atmospheres and temperatures between -40°C up to +80°C (-40°F up to 176°F).
- Automated (production) processes where a minimum and / or a maximum dispensed quantity has to be monitored continuously. For DIN panel mount indicators, check our [D-Series](#).

General information

Introduction

The F117 has been developed for applications where the totalized quantity has to be monitored and not the flow rate. When a start-command is given, the totalizer is reset to zero. The amount of product measured from that moment is monitored continuously for high totalizer values. Monitoring for low alarm values will commence after a stop-command is given or after a pre-defined process time. The alarm values itself are entered as a percentage of the preset value and are immediately converted to a displayed quantity, also after change of the preset value. A totalizer alarm will be displayed clearly while an external device can be controlled with the alarm outputs.

Display

The display has large 17mm (0.67") and 8mm (0.31") digits which shows the actual totalized quantity, preset value, percentage and alarm values. The alarm values can be password protected. On-screen engineering units are easily configured from a comprehensive menu. The accumulated total and flow rate can be displayed after a monitoring process only. For those applications where readability during day and night is an issue, a white backlight is available.

Configuration

All configuration settings are accessed via a simple operator menu which can be password protected. Each setting is clearly indicated with an alpha-numerical description, which avoids confusing abbreviations and baffling codes. Once familiar with one F-series product, you will be able to program all models in the series without a manual. All settings are safely stored in EEPROM memory in the event of sudden power failure.

Analog output signal

The (o)4 - 20mA or 0 - 10V DC analog output value mirrors the flow rate or the measured quantity in relation to the preset value. The output signal is updated eight times per second. The output value will be e.g. 4mA after the start-command and being 20mA at reaching the preset value. The output signal can be passive, active or isolated where the passive -output type will loop power the F117 as well.

Alarm output

Two alarm outputs are available to transmit the high or low totalizer alarm condition. The output signals can be a passive NPN, active PNP or an isolated electro-mechanical relay.

Signal input

The F117 accepts most pulse input signals for volumetric flow or mass flow measurement. The input signal type can be selected by the user in the configuration menu. Additional inputs are available for remote control, bi-directional measurement or higher input resolution (sum function).

Communication

All process data and settings can be read and modified manually or through the Modbus communication link (RS232 / RS485).

Full Modbus functionality remains available for the Intrinsically Safe version (TTL).

Hazardous areas

This model has been ATEX and IECEx certified Intrinsically Safe for gas and dust applications, with an allowed ambient temperature of -40°C to +70°C (-40°F to +158°F). A flame proof Ex d enclosure with ATEX certification is also available.

Enclosures

Various types of enclosures can be selected, all ATEX and IECEx approved. As standard the F117 is supplied in an GRP panel mount enclosure, which can be converted to an GRP field mount enclosure. Most popular is our rugged aluminum field mount enclosure with IP67 / NEMA Type4X rating. Both European or U.S. cable gland entry threads are available.

Overview application F117

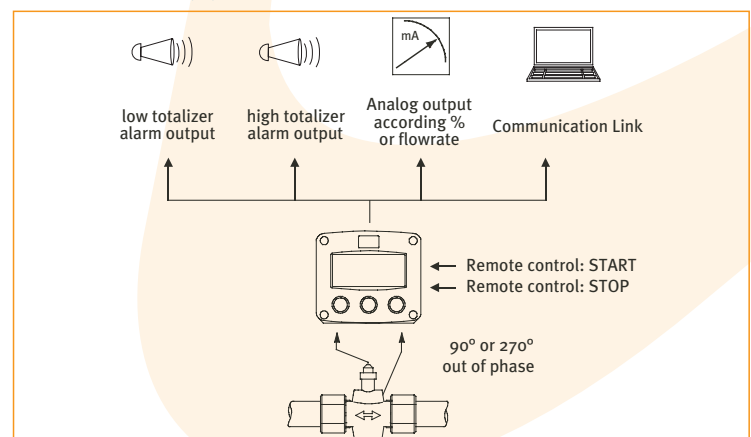

Dimensions enclosures

Aluminum & GRP panel mount enclosure

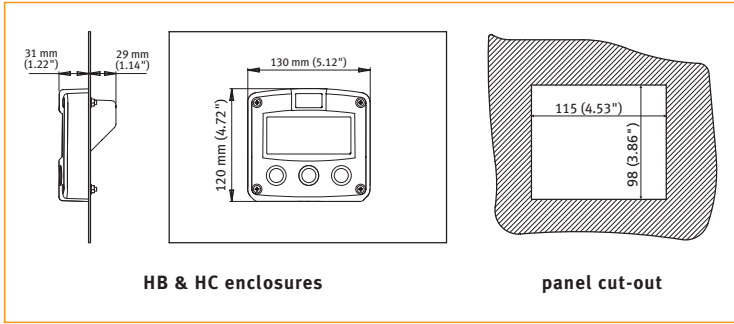

HB & HC enclosures

panel cut-out

Aluminum & GRP field / wall mount enclosures

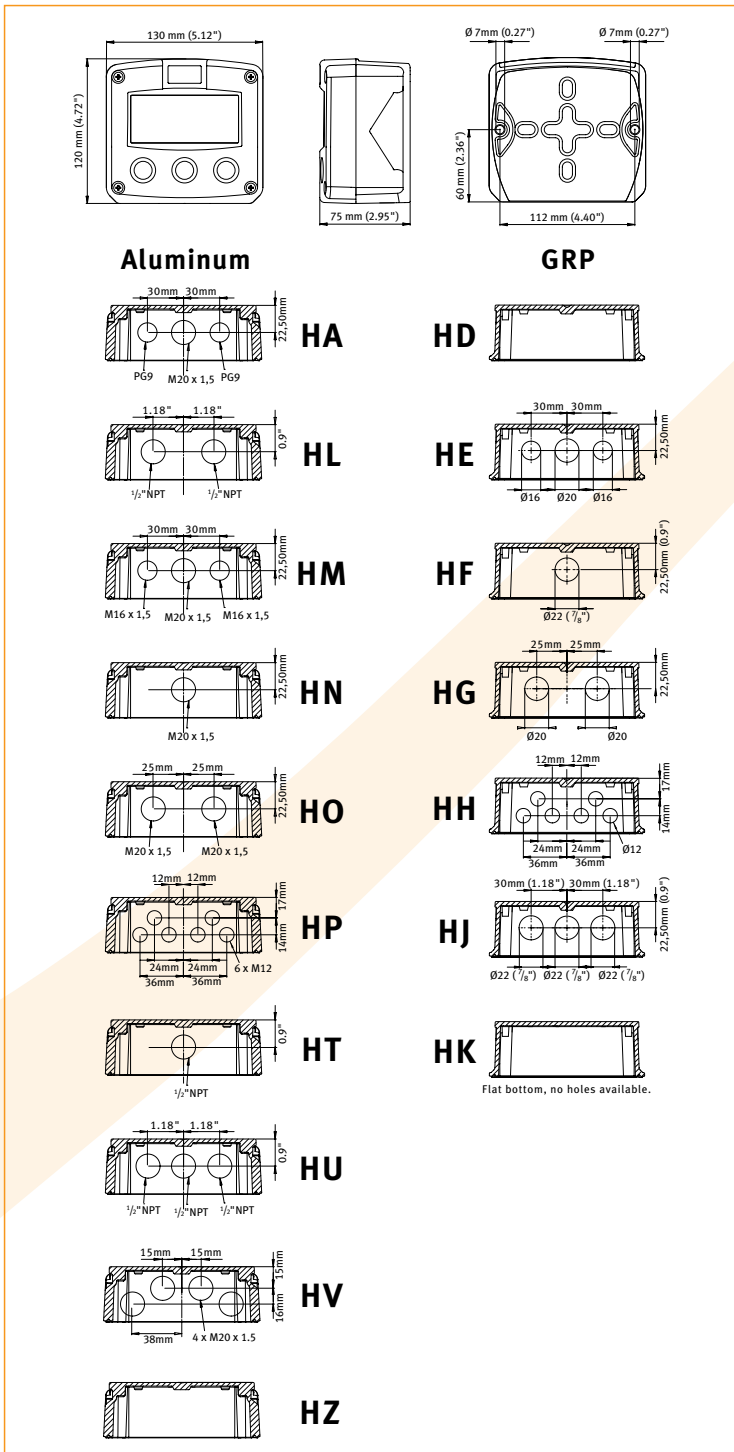

Aluminum

GRP

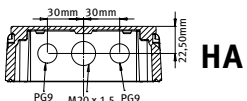

HA

HD

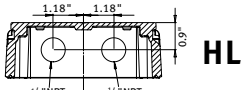

HL

HE

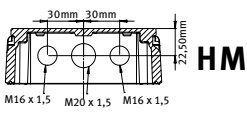

HM

HF

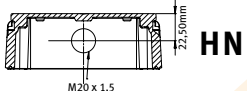

HN

HG

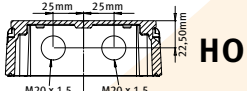

HO

HH

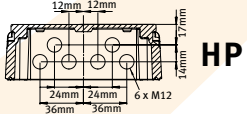

HP

HJ

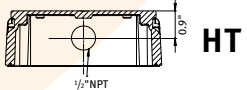

HT

HK

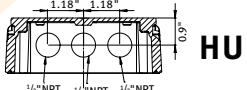

HU

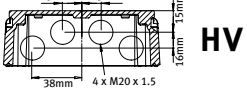

HV



HZ

Flat bottom, no holes available.

Terminal connections

31	30	29	28	27	26	25	24	23	22	21	20	19	18	17	16	15	14	13	12	11	10	09	08	07	06	05	04	03	02	01																																			
COMMUNICATION						ADDITIONAL INPUT						FLOWMETER INPUT B (ADDITIONAL INPUT)						FLOWMETER INPUT A						ANALOG OUTPUT						LOW ALARM OUTPUT R1						HIGH ALARM OUTPUT R2						POWER REQUIREMENTS																							
GSE, RS232C DTR +12V TXD						CH, RS485 - 2 wire A B						CI, RS485 - 4 wire A B Y Z						CT, TTL Intrinsically Safe DTR +12V TXD						P: coil P: need switch / NPN P: PNP P: alarm P: active signal Start						P: coil P: need switch / NPN P: PNP P: alarm P: active signal						AA: 4 - 20mA IL: ↑ I: ↑ AB: 0 - 20mA IL: ↑ I: ↑ AF: 4 - 20mA I: ↓ I: ↑ AI: 4 - 20mA I: ↓ I: ↑ AP: 4 - 20mA I: ↓ I: ↑ AU: 0 - 10V I: ↓ I: ↑						OA: active 24V DC OT: passive trans OR: mech. relay						OA: active 24V DC OT: passive trans OR: mech. relay						PD: 8 - 24V AC PD: 8 - 24V DC PD - XI: 16 - 30V DC PF: 24V AC PF: 24V DC PM: 115 - 230V AC PX: 8 - 30V DC ZB: Backlight: 12 - 24V DC						AP: 8 - 30V DC Output loop powered PB / PC: battery powered Internal long life Lithium battery					

(Note: configuration setting for bi-directional / sum measurement or control inputs.)

Display example - 90 x 40mm (3.5" x 1.6")

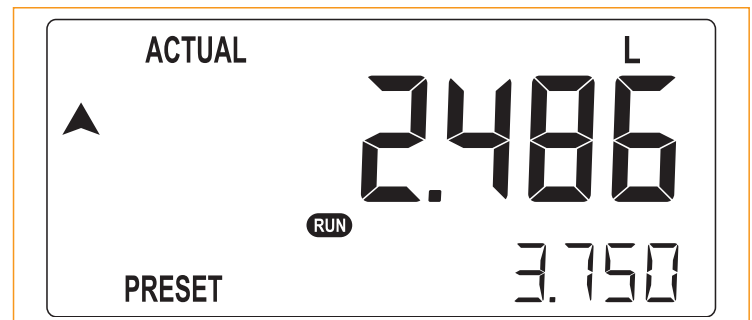

Typical wiring diagram F117-P-(AP)-CH-(OT)-PB-(PX)

Typical wiring diagram F117-P-AP-CH-OT-PX

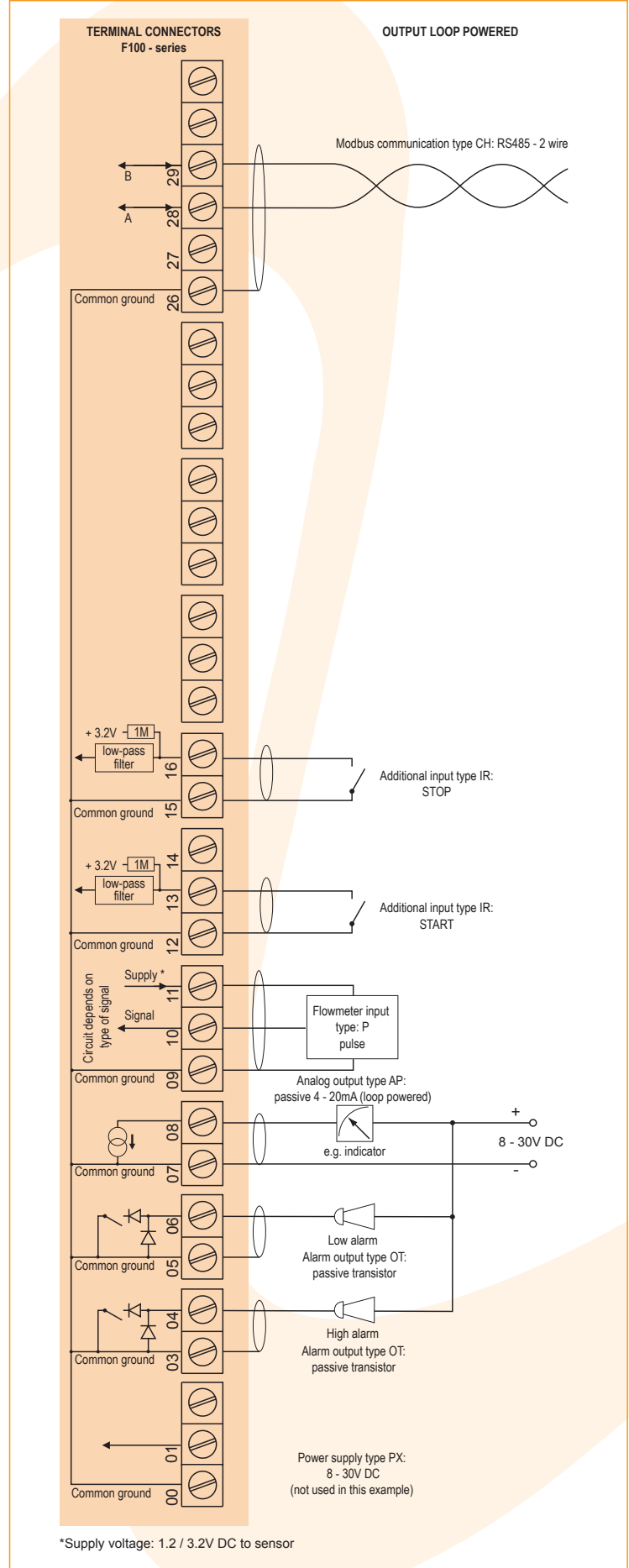
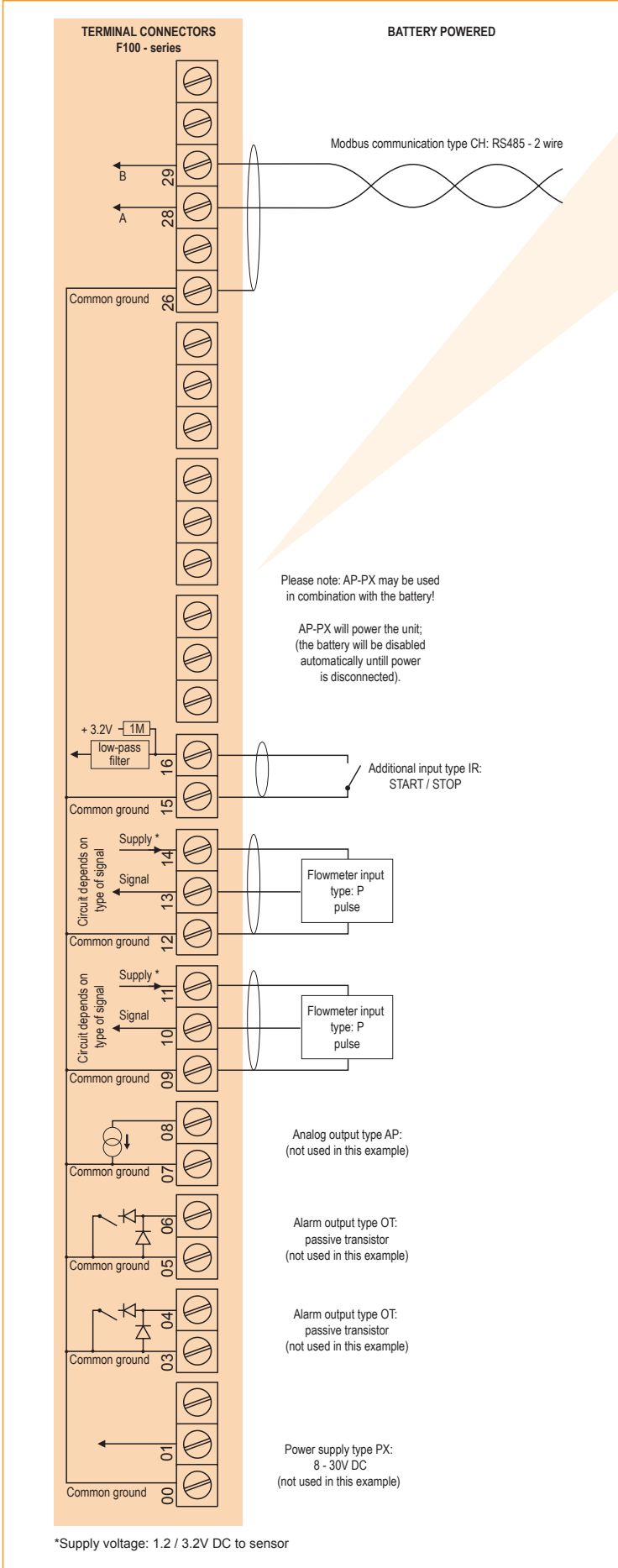

Typical wiring diagram F117-P-AA-CB-OA-PD

Typical wiring diagram F117-P-AI-CI-OR-PM

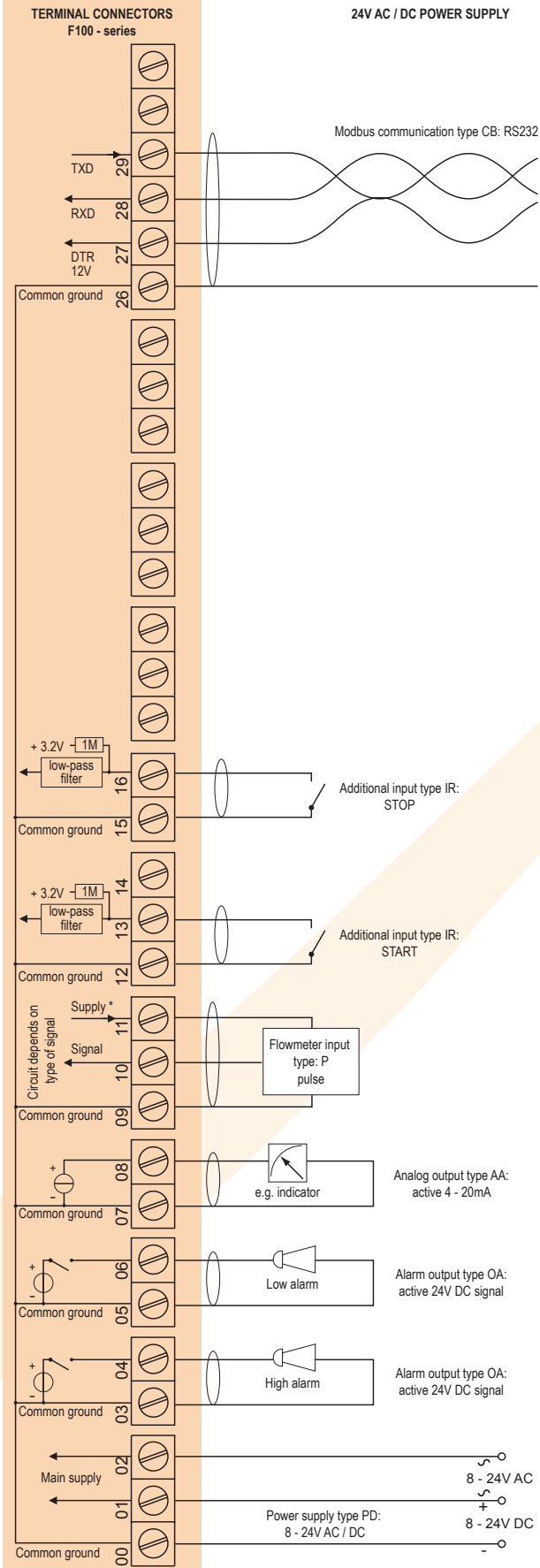

*Supply voltage: 1.2 / 3.2 / 8.2 / 12 / 24V DC to sensor

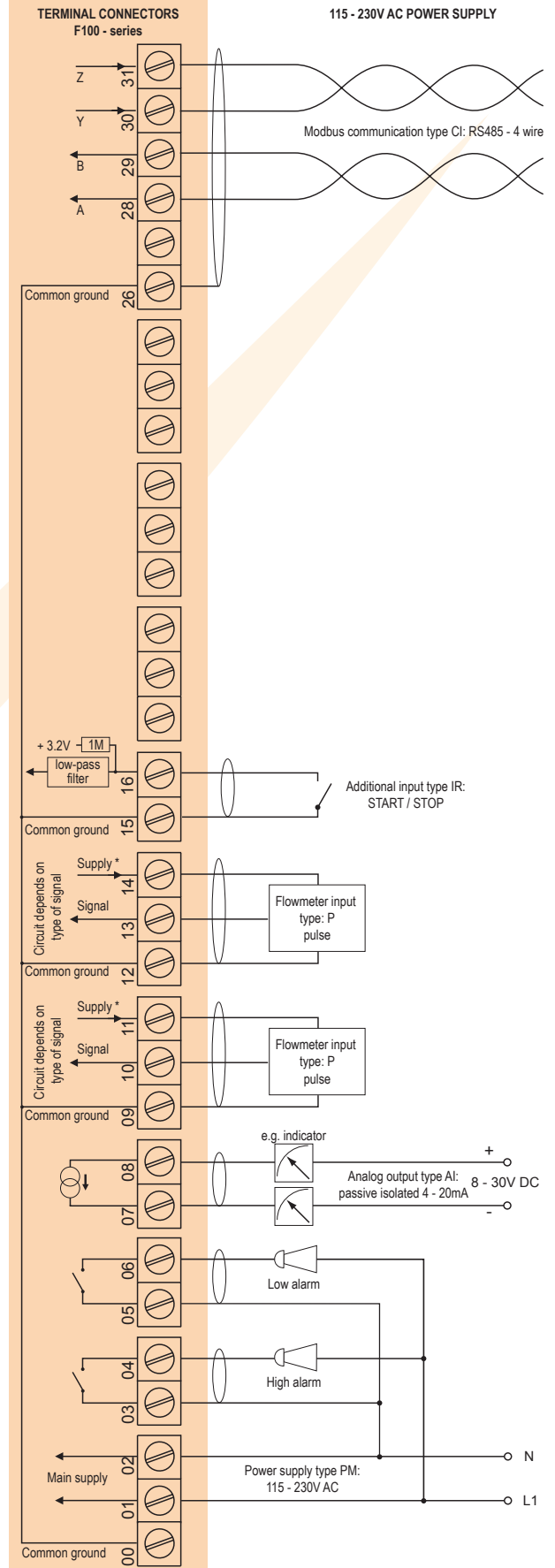

*Supply voltage: 1.2 / 3.2 / 8.2 / 12 / 24V DC to sensor

Hazardous area applications

The F117-XI has been certified according ATEX and IECEx by DEKRA for use in Intrinsically Safe applications with an ambient temperature of -40°C to +70°C (-40°F to +158°F).

- The ATEX markings for gas and dust applications are:

II 1 G Ex ia IIB/IIC T4 Ga
II 1 D Ex ia IIIC T100 °C Da.

- The IECEx markings for gas and dust applications are: **Ex ia IIC/IIB T4 Ga** and **Ex ia IIIC T100 °C Da.**

Besides the I.S. power supplies for the two alarm outputs, it is allowed to connect up to four I.S. power supplies in IIB/IIC applications or one in IIC applications. Consult the certificate for the maximum input and output values of the circuits. Full functionality of the F117 remains available, including two alarm and 4 - 20mA output and Modbus communication (type CT). Power supply type PD-XI offers a 8.2V sensor supply e.g. for one Namur sensor. An ATEX approved flame proof Ex d enclosure is available as well. Please contact your supplier for further details.

Certificate of conformity KEMA 03ATEX1074 X • IECEx DEK 11.0042X

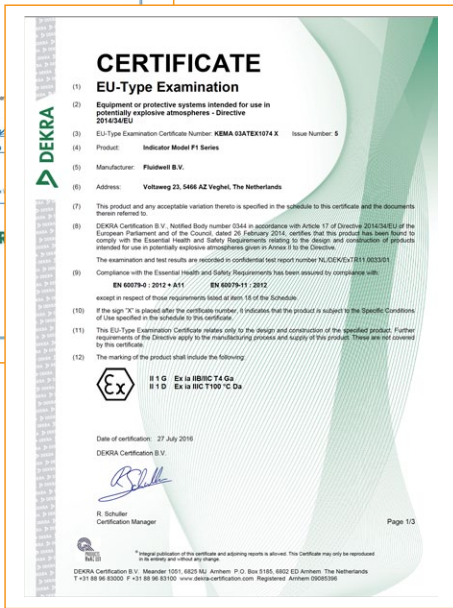
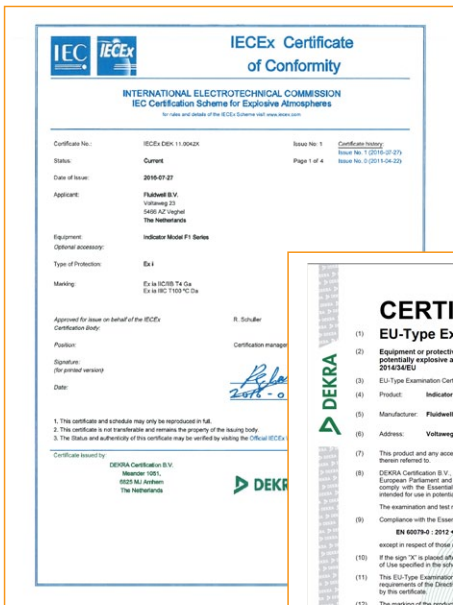

Configuration example IIB / IIC and IIC F117-P-(AP)-(CT)-(OT)-PC-XI - Battery powered unit

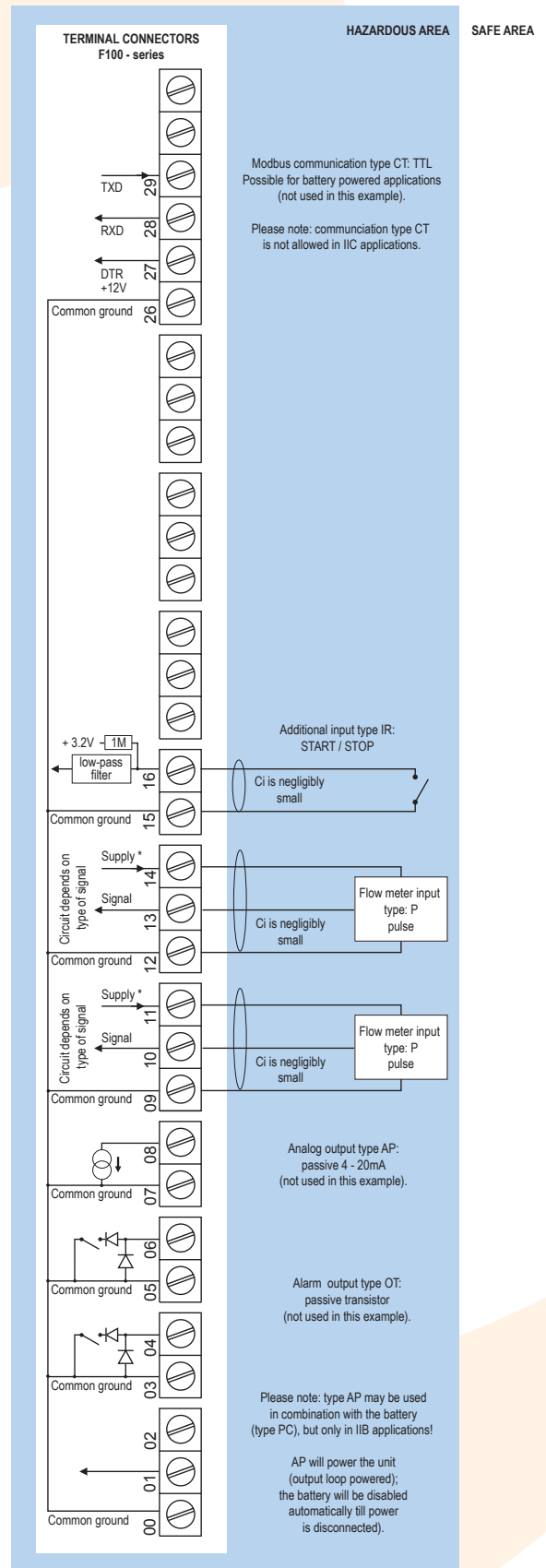

* Note sensor supply voltage: 1.2V DC for coil sensors or 3.2V DC for other pulse sensors.

Configuration example IIB / IIC and IIC - F117-P-AP-(CT)-OT-(PX)-XI - Output loop powered

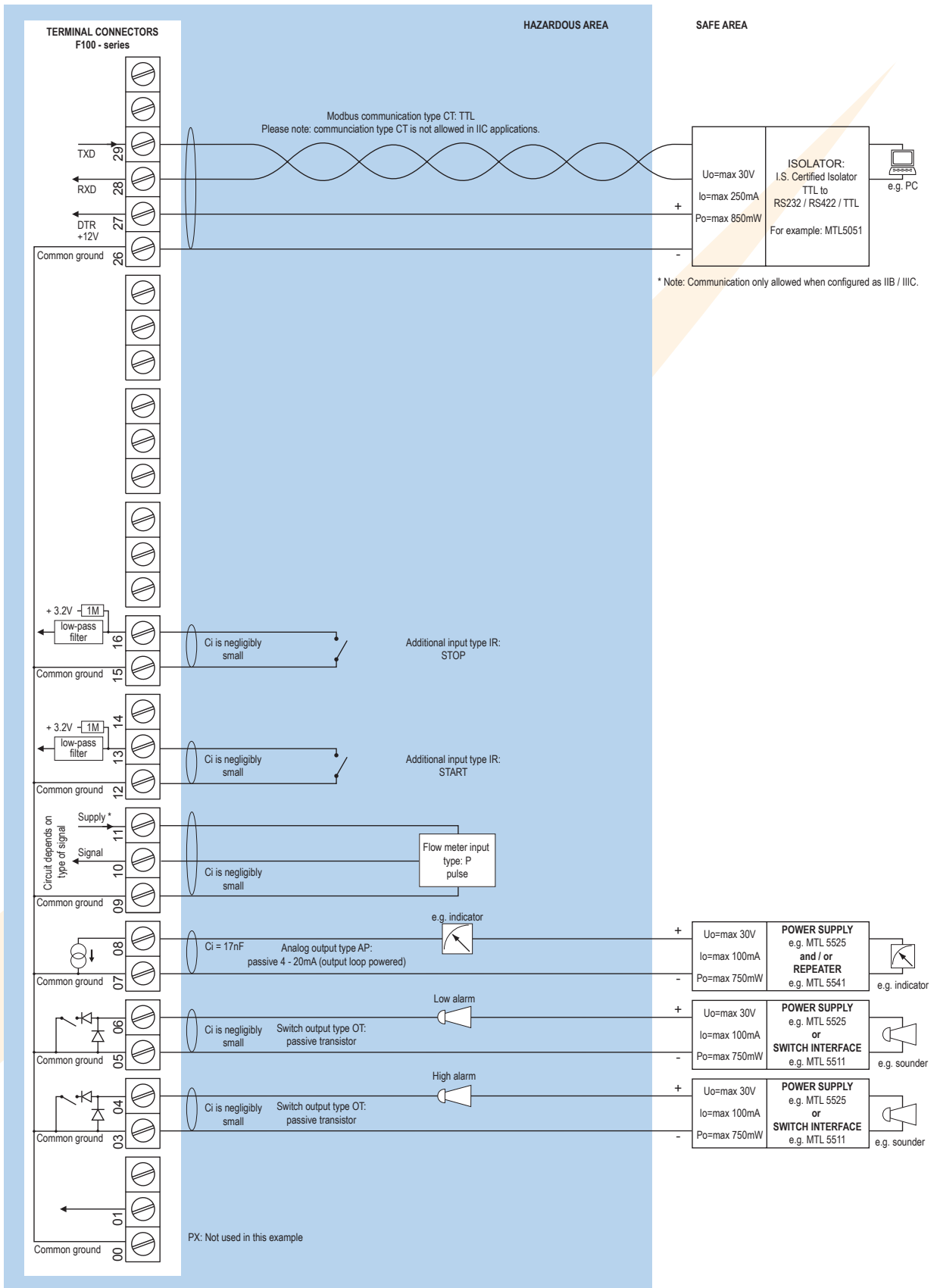

* Note sensor supply voltage: 1.2V DC for coil sensors or 3.2V DC for other pulse sensors.

Configuration example IIB / IIIC and IIC - F117-P-AF-(CT)-OT-PD-XI - Power requirement 16 - 30V DC

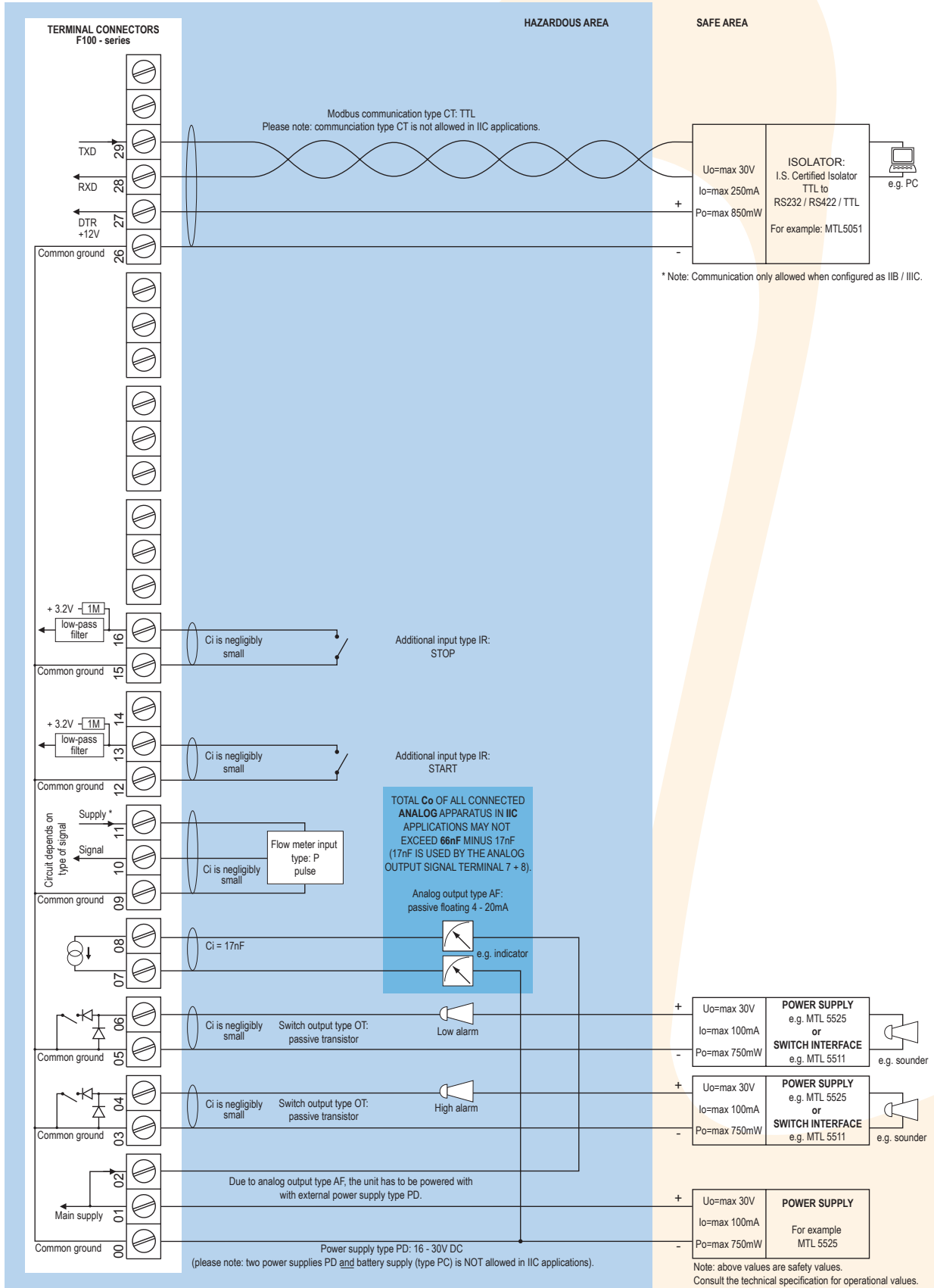

* Note power supply type PD: the supply voltage to pulse sensors is maximum 8.7V (Uo=max 8.7V Io=max 25mA Po=max 150mW).

Configuration example IIB / IIIC - F117-P-AP-CT-OT-(PD)-XI - Power requirement 16 - 30V DC

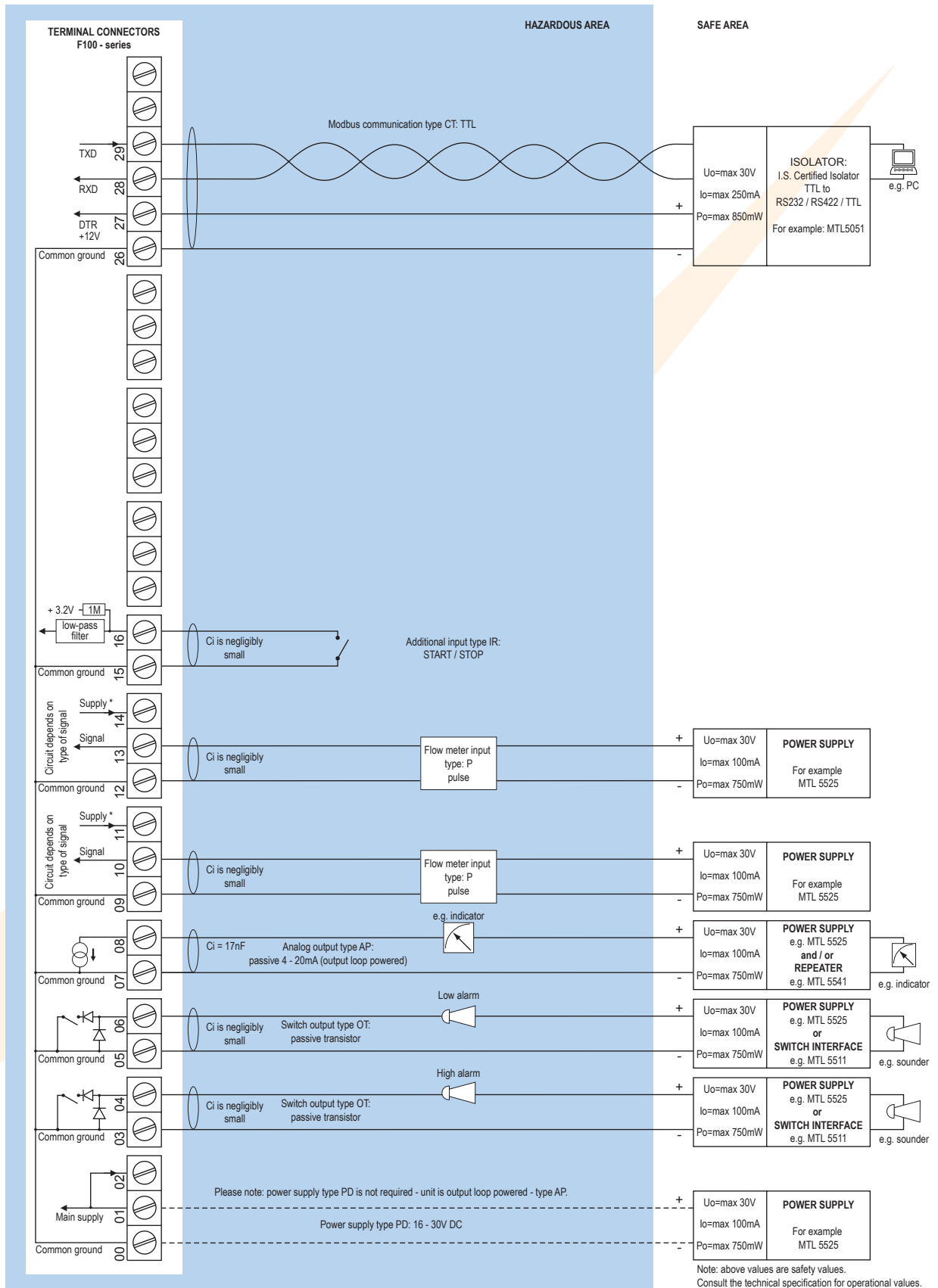

* Note power supply type PD: the supply voltage to pulse sensors is maximum 8.7V (Uo=max 8.7V Io=max 25mA Po=max 150mW).

Technical specification

General

Display	
Type	High intensity reflective numeric and alphanumeric LCD, UV-resistant.
Dimensions	90 x 40mm (3.5" x 1.6").
Digits	Seven 17mm (0.67") and eleven 8mm (0.31") digits. Various symbols and measuring units.
Refresh rate	User definable: fast, 1sec, 3sec, 15sec, 30sec, off.
Option ZB	Transflective LCD with white LED-backlight. Good readings in full sunlight and darkness.
Note ZB	Only available for safe area applications.

Ambient temperature

Safe areas	-40°C to +80°C (-40°F to +176°F).
Intrinsically Safe	-40°C to +70°C (-40°F to +158°F).

Power requirements

Type AP	Analog output loop powerd, 8 - 30V DC. Power consumption max 0.5 Watt.
Type PB	Long life Lithium battery - life-time depends upon settings and configuration - up to 5 years. (requires PD or PX)
Type PC	Intrinsically Safe long life lithium battery - life-time depends upon settings and configuration - up to 5 years. (requires XI and PD or PX)
Type PD	8 - 24V AC / DC ± 10%. Power consumption max. 10 Watt. Intrinsically Safe: 16 - 30V DC; power consumption max. 0.75 Watt.
Type PF	24V AC / DC ± 10%. Power consumption max. 15 Watt.
Type PM	115 - 230V AC ± 10%. Power consumption max. 15 Watt.
Type PX	8 - 30V DC. Power consumption max. 0.5 Watt.
Type ZB	12 - 24V DC ± 10%. Power consumption max. 1 Watt.
Note PB/PF/PM	Not available Intrinsically Safe.
Note PF/PM	The total consumption of the sensors and outputs may not exceed 400mA @ 24V.
Note	For Intrinsically Safe applications, consult the safety values in the certificate.

Sensor excitation

Type PB/PC/PX	3V DC for pulse signals and 1.2V DC for coil pick-up.
Note	This is not a real sensor supply. Only suitable for sensors with a very low power consumption like coils (sine wave) and reed-switches.
Type PD	1.2 / 3 / 8.2 / 12 / 24V DC - max. 50mA @ 24V DC.
Type PD-XI	1.2 / 3 / 8.2V DC - max. 7mA @ 8.2V DC and mains power supply voltage (as connected to terminal 1).
Type PF / PM	1.2 / 3 / 8.2 / 12 / 24V DC - max. 400mA @ 24V DC.

Terminal connections

Type	Removable plug-in terminal strip. Wire max. 1.5mm ² and 2.5mm ² .
------	---

Data protection

Type	EEPROM backup of all settings. Backup of running totals every minute. Data retention at least 10 years.
Password	Configuration settings can be password protected.

Directives & Standards

EMC	Directive 2014/30/EU, FCC 47 CFR part 15.
Low voltage	Directive 2014/35/EU
RoHS	Directive 2011/65/EU
ATEX / IECEx	Directive 2014/34/EU, IEC 600079-0, IEC 60079-11.
IP & NEMA	EN 60529 & NEMA 250

Enclosure

General	
Window	Polycarbonate window.
Sealing	Silicone.
Control keys	Three industrial micro-switch keys. UV-resistant silicone keypad.

Aluminum wall / field mount enclosures

General	Die-cast aluminum wall/field mount enclosure IP67 / NEMA Type4X with 2-component UV-resistant coating.
Dimensions	130 x 120 x 75mm (5.12" x 4.72" x 2.95") - W x H x D.
Weight	1100 gr.
Type HA	Cable entry: 2 x PG9 and 1 x M20.
Type HL	Cable entry: 2 x 1/2" NPT.
Type HM	Cable entry: 2 x M16 and 1 x M20.
Type HN	Cable entry: 1 x M20.
Type HO	Cable entry: 2 x M20.
Type HP	Cable entry: 6 x M12.
Type HT	Cable entry: 1 x 1/2" NPT.
Type HU	Cable entry: 3 x 1/2" NPT.
Type HV	Cable entry: 4 x M20.
Type HZ	Cable entry: no holes.

GRP wall / field mount enclosures



General	GRP wall/field mount enclosure IP67 / NEMA Type4X, UV-resistant and flame retardant.
Dimensions	130 x 120 x 75mm (5.12" x 4.72" x 2.95") - W x H x D.
Weight	600 gr.
Type HD	Cable entry: no holes.
Type HE	Cable entry: 2 x Ø 16mm and 1 x Ø 20mm.
Type HF	Cable entry: 1 x Ø 22mm (7/8").
Type HG	Cable entry: 2 x Ø 20mm.
Type HH	Cable entry: 6 x Ø 12mm.
Type HJ	Cable entry: 3 x Ø 22mm (7/8").
Type HK	Flat bottom, cable entry: no holes.

Panel mount enclosures

Dimensions	130 x 120 x 60mm (5.12" x 4.72" x 2.36") - W x H x D.
Panel cut-out	115 x 98mm (4.53" x 3.86") L x H.
Type HB	Die-cast aluminum panel mount enclosure IP65 / NEMA Type4X.
Weight	600 gr.
Type HC	GRP panel mount enclosure IP65 / NEMA Type4X, UV-resistant and flame retardant.
Weight	450 gr.

Hazardous area

Intrinsically Safe (Type XI)

ATEX certification	 II 1 G Ex ia IIB/IIC T4 Ga. II 1 D Ex ia IIIC T100 °C Da.
IECEx certification	 Ex ia IIC/IIB T4 Ga.  Ex ia IIIC T100 °C Da.
Ambient Ta	-40°C to +70°C (-40°F to +158°F).

Explosion proof (Type XF)

ATEX certification  II 2 G / Ex d IIB T5 Gb.
II 2 D / Ex t IIB T100 °C Db.

Type XF Dimensions of enclosure: 300 x 250 x 200mm
(11.8" x 9.9" x 7.9") L x H x D.

Weight Appr. 15kg.

Note IECEx available on request.

Signal inputs

Flowmeter

Type P Coil / sine wave (HI: 20mVpp or LO: 80mVpp - sensitivity selectable), NPN/PNP, open collector, reed-switch, Namur, active pulse signals 8 - 12 and 24V DC.

Note Two flowmeter inputs are available for bi-directional measurement or to create a higher resolution by incrementing both pulse trains (sum function). Alternatively, the second input can be used for remote control.

Frequency Minimum 0Hz - maximum 7kHz for total and flow rate and single pulse. Double pulse max. 3.5kHz without communications and 2.5kHz with communications. Maximum frequency depends on signal type and internal low-pass filter. E.g. reed switch with low-pass filter: max. frequency 120Hz.

K-Factor 0.000010 - 9,999,999 with variable decimal position.

Low-pass filter Available for all pulse signals.

Option ZF coil sensitivity 10mVpp.

Additional inputs

Function Two inputs to start / stop the monitoring function.

Type IR Internally pulled-up switch contact - NPN.

Duration Minimum pulse duration 100msec.

Signal outputs

Analog output

Function Mirrors the flow rate or the measured quantity in relation to the preset value.

Accuracy 10 bit. Error < 0.05%. Analog output signal can be scaled to any desired range.

Update time Eight times per second.

Type AA Active 4 - 20mA output (requires PD, PF, PM or PX).

Type AB Active 0 - 20mA output (requires PD, PF, PM or PX).

Type AF Passive floating 4 - 20mA output for Intrinsically Safe applications (requires XI + PD or PX).

Type AI Passive galvanically isolated 4 - 20mA output - also available for battery powered models.

Type AP Passive 4 - 20mA output - not isolated. Unit will be loop powered.

Type AU Active 0 - 10V DC output (requires PD, PF, PM or PX).

Digital outputs

Function Two outputs: low and high totalizer alarm.

Type OA Two active 24V DC transistor outputs (PNP); max. 50mA per output (requires PD, PF, PM or PX).

Type OR Two electro-mechanical relay outputs (N.O.) - isolated; max. switch power 230V AC - 0.5A per relay (requires PF or PM).

Type OT Two passive transistor outputs (NPN) - not isolated. Max. 50V DC - 300mA per output.

Communication option

Function Reading display information, reading / writing all configuration settings.

Protocol Modbus RTU.

Speed 1200 - 2400 - 4800 - 9600 baud.

Addressing Maximum 255 addresses.

Type CB RS232

Type CH RS485 2-wire

Type CI RS485 4-wire

Type CT TTL Intrinsically Safe.

Operational

Operator functions

Displayed functions

- Preset value - can be entered by the operator.
- Actual totalized quantity.
- Percentage: totalized quantity in relation to the preset value.
- Low total alarm value.
- High total alarm value.
- Accumulated total.
- Flow rate.

Preset

Digits 7 digits.

Units L, m³, GAL, USGAL, kg, lb, bbl, no unit.

Decimals 0 - 1 - 2 or 3.

Accumulated total

Digits 11 digits.

Units / decimals According to selection for total.

Note Can not be reset to zero; not displayed during process.

Flow rate

Digits 7 digits.

Units mL, L, m³, Gallons, kg, Ton, lb, bl, cf, RND, ft³, scf, Nm³, NL, ical - no units.

Decimals 0 - 1 - 2 or 3.

Time units /sec - /min - /hr - /day.

Note Not displayed during process.

Alarm values

Digits 7 digits.

Units According to selection for total / preset.

Decimals According to selection for total / preset.

Time units According to selection for total / preset.

Type of alarm low and high totalizer alarm.

Note The alarm values have to be entered as a percentage of the preset quantity. The unit will calculate and display the absolute value automatically.

Percentage

Digits 4 digits - 000.1 - 999.9 %.

Accessories

Mounting accessories

ACFo2 Stainless steel wall mounting kit.

ACFo5 Stainless steel pipe mounting kit (worm gear clamps not included).

ACFo6 Two stainless steel worm gear clamps Ø 44 - 56mm.

ACFo7 Two stainless steel worm gear clamps Ø 58 - 75mm.

ACFo8 Two stainless steel worm gear clamps Ø 77 - 95mm.

ACFo9 Two stainless steel worm gear clamps Ø 106 - 138mm.

ACF11 Swivel with 25° movement from center axis for direct flowmeter mounting: 1" NPT to 1/2" NPT.

Ordering information

Standard configuration: F117-P-AP-CX-HC-IR-OT-PX-XX-ZX.

Ordering information:

F117 -P -A -C -H -IR -O -P -X -Z

Flowmeter input signal

P  **Pulse input: coil, npn, pnp, namur, reed-switch.**

Analog output signal

AA Active 4 - 20mA output - requires PD, PF, PM or PX.

AB Active 0 - 20mA output - requires PD, PF, PM or PX.

AF  I.S. floating 4 - 20mA output - requires XI + PD or PX.

AI Isolated 4 - 20mA output.

AP  **Passive 4 - 20mA output, loop powered unit.**

AU Active 0 - 10V DC output - requires PD, PF, PM or PX.

Communication

CB Communication RS232 - Modbus RTU.

CH Communication RS485 - 2-wire - Modbus RTU.

CI Communication RS485 - 4-wire - Modbus RTU.

CT  Intrinsically Safe TTL - Modbus RTU.

CX  **No communication.**

Panel mount enclosures - IP65 / NEMA Type4X

HB  Aluminum enclosure.

HC  **GRP enclosure.**

GRP field / wall mount enclosures - IP67 / NEMA Type4X

HD  Cable entry: no holes.

HE  Cable entry: 2 x Ø 16mm & 1 x Ø 20mm.

HF  Cable entry: 1 x Ø 22mm (7/8").

HG  Cable entry: 2 x Ø 20mm.

HH  Cable entry: 6 x Ø 12mm.

HJ  Cable entry: 3 x Ø 22mm (7/8").

HK  Flat bottom, cable entry: no holes.

Aluminum field / wall mount enclosures - IP67 / NEMA Type4X

HA  Cable entry: 2 x PG9 + 1 x M20.

HL  Cable entry: 2 x 1/2" NPT.

HM  Cable entry: 2 x M16 + 1 x M20.

HN  Cable entry: 1 x M20.

HO  Cable entry: 2 x M20.

HP  Cable entry: 6 x M12.

HT  Cable entry: 1 x 1/2" NPT.

HU  Cable entry: 3 x 1/2" NPT.

HV  Cable entry: 4 x M20.

HZ  Cable entry: no holes.

Additional input signal

IR  **Remote control input to start, stop or slope.**

Digital output signals

OA Two active transistor outputs - requires PD, PF, PM or PX.

OR Two mechanical relay outputs - requires PF or PM.

OT  **Two passive transistor outputs - standard configuration.**

Power requirements

PD  8 - 24V AC/DC + sensor supply - with XI: 16 - 30V DC.

PF 24V AC/DC + sensor supply.

PM 115 - 230V AC + sensor supply.

PX  **Basic power supply 8 - 30V DC (no real sensor supply).**

Additional battery supply (optional)

PB Lithium battery powered - requires PD or PX.

PC  Lithium battery powered - Intrinsically Safe - requires XI, and PD or PX.

Hazardous area

XI  Intrinsically Safe, according ATEX and IECEx.

XF Ex d enclosure - 3 keys according ATEX.

XX **Safe area only.**

Other options

ZB Backlight.

ZF  Coil input 10mVpp.

ZX  **No options.**

The bold marked text contains the standard configuration.

 Available Intrinsically Safe.

Specifications are subject to change without notice.



Quality
ISO 9001

www.dekra-seal.com

Fluidwell bv

P.O. Box 6

5460 AA - Veghel - The Netherlands

Telephone: +31 (0)413 343 786

Telefax: +31 (0)413 363 443

email: displays@fluidwell.com

Internet: www.fluidwell.com

