

RATIO CONTROLLER

WITH ANALOG CONTROL OUTPUT
AND HIGH / LOW ALARMS



Advantages

- Robust IP67 (NEMA Type4X) field enclosure. It is so rugged, **you can even stand on it!**
- Intrinsically Safe available - ATEX and IECEx approval for gas and dust applications.
- Programming can be done by your own crew, with the sensible menu-driven structure, saving cost and irritation. **Know one, know them all!**
- Very diverse mounting possibilities: walls, pipes, panels or directly onto outdoor sensors!

Features

- Controls the desired ratio between a main and an additive flow.
- Displays flow rate A and B, alarms, ratio setpoint and actual ratio in percentage.
- Safety mode input to place the controller in a safe predefined position.
- Two alarm values can be entered in %: low and high ratio alarm.
- Easy operation mode switching : Hand/Local/Ratio.
- Explosion/flame proof available.
- Full Modbus communication RS232/485/TTL.
- Loop or battery powered, 8 - 24V AC / DC or 115 - 230V AC power supply.

Signal output

- (0)4 - 20mA / 0 - 10V DC control output.
- Two alarm outputs for low and high ratio alarm.

Signal input

Flow

- Ability to process all types of flowmeter signals: Reed-switch, NAMUR, NPN/PNP pulse, Sine wave (coil), Active pulse signals, (0)4 - 20mA.

Remote control

- Safety mode input.

Applications

- The F-Series is your first and safest choice for field mount indicators in safe and hazardous area applications. Especially in harsh weather conditions like rain, snow, salty atmospheres and temperatures between -40°C up to +80°C (-40°F up to 176°F).
- In-line blending can be significantly affected by its control operations. The F124 ratio controller will show a strong influence of maintaining a good and constant quality of products and saves money on the blending components. For DIN panel mount indicators, check our D-Series.

General information

Introduction

The F124 has been designed to ensure that two flows are kept at the same ratio even if the flows are changing. The F124 is a key product of the Fluidwell Process Controller family and is the alternative to replace existing pneumatic controllers in local control loops.

Operational

There are three operation modes:

Hand: the control output can be manually changed, there is no loop connection.

Local: the setpoint can be set and/or changed, corresponding with the process value of flow B.

Ratio: (normal operation) set the desired ratio in %, the process value corresponds with flow B/A .

Display

The display has large 17mm segments which show flowrate A and B, desired ratio and actual ratio. On-screen engineering units are easily configured from a comprehensive selection.

Configuration

All configuration settings are accessed via a simple operator menu which can be password protected. Each setting is clearly indicated with an alphanumerical description, which avoids confusing abbreviations and baffling codes. Once familiar with one F-series product, you will be able to program all models in the series without a manual. All settings are safely stored in EEPROM memory in the event of sudden power loss.

Analog output signal

The valve of the additive flow is controlled via the (o)4 - 20mA or o - 10V DC output signal. The output signal is updated eight times per second. The output signal can be passive, active or isolated where the passive output type will loop power the F124 as well.

Signal input

The F124 accepts most pulse and analog input signals for volumetric flow or mass flow. The input signal type can be selected by the user in the configuration menu without having to adjust any sensitive mechanical dip-switches or jumpers. The analog input is available with linear and square root calculation and even as 4 - 20mA input loop powered.

Alarm output

Two fixed alarm outputs are available to transmit the ratio alarm condition, 1 low and 1 high alarm output. The output signals can be a passive NPN, active PNP or an isolated electro-mechanical relay. If there is a no-flow the alarm output will be disabled.

Safety mode

The F124 has a safety mode that keeps on transmitting a pre-defined value as long as the contact is made. After releasing the contact, the former value and function will be reinstalled.

Communication

All process data and settings can be read and modified manually or through the Modbus communication link (RS232 / RS485). Full Modbus functionality remains available for the Intrinsically Safe version (TTL).

Hazardous areas

This model has been ATEX and IECEx certified Intrinsically Safe for gas and dust applications, with an allowed ambient temperature of -40°C to +70°C (-40°F to +158°F). A flame proof Ex d enclosure with ATEX certification is also available.

Enclosures

All enclosures are ATEX and IECEx approved. As standard the F124 is supplied in an GRP panel mount enclosure, which can be converted to an IP67 / NEMA Type4X GRP field mount enclosure by the addition of a back case. Most popular is our rugged aluminum field mount enclosure.

Overview application F124

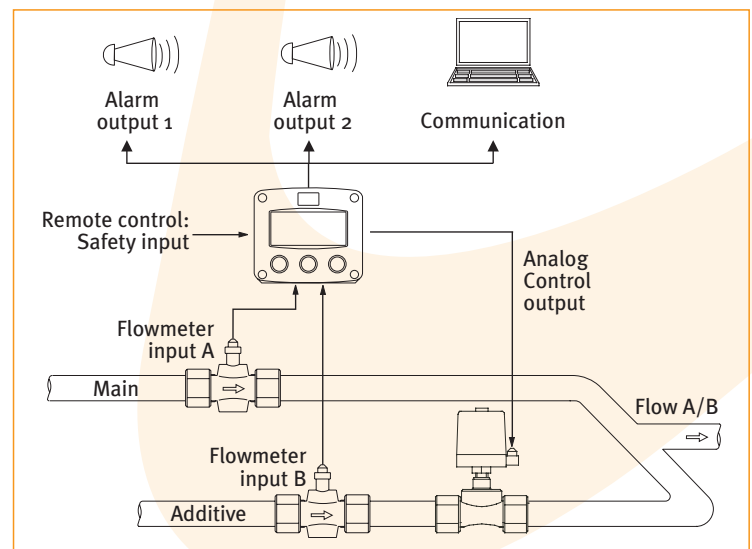

Dimensions enclosures

Aluminum & GRP panel mount enclosure

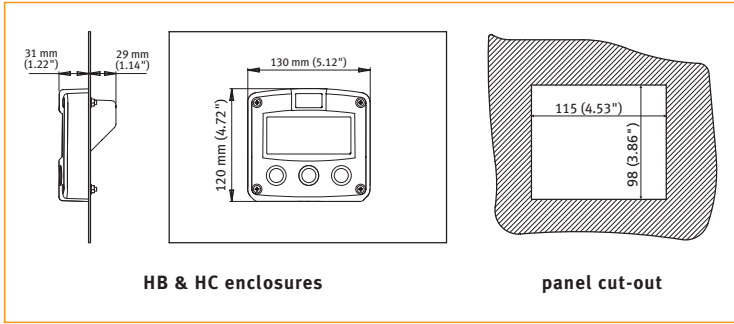

HB & HC enclosures

panel cut-out

Aluminum & GRP field / wall mount enclosures

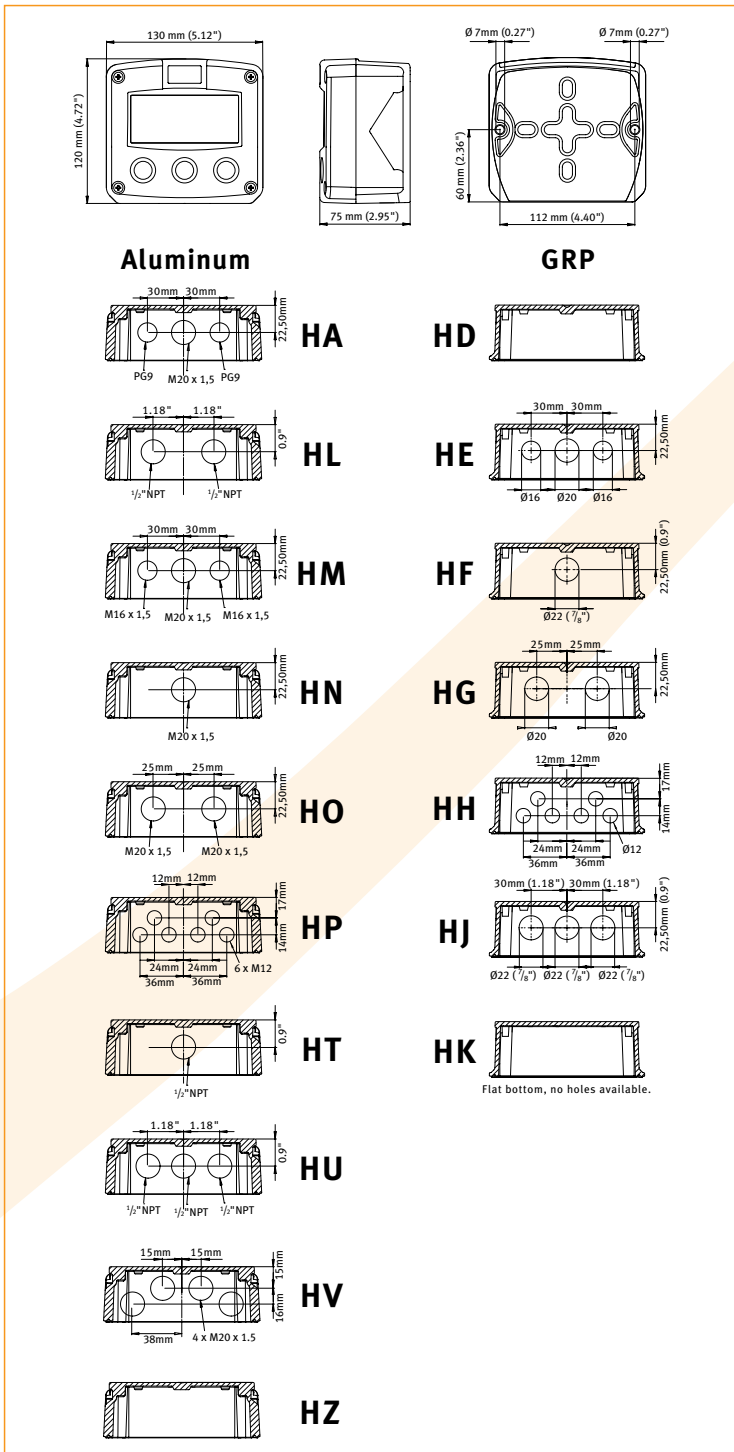

Aluminum

GRP

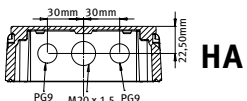

HA



HD

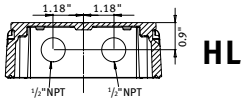

HL

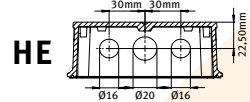

HE

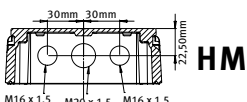

HM

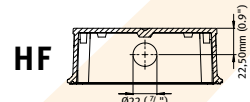

HF

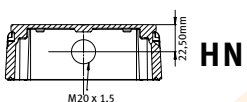

HN

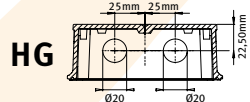

HG

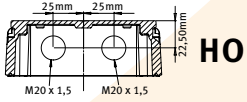

HO

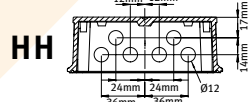

HH

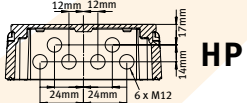

HP

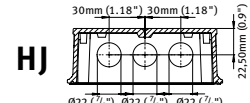

HJ

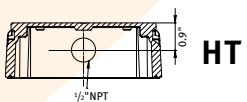

HT

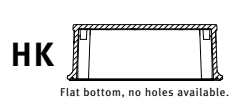

HK

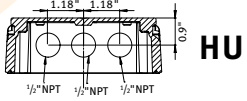

HU

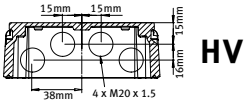

HV

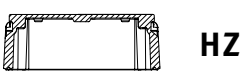

HZ

Terminal connections

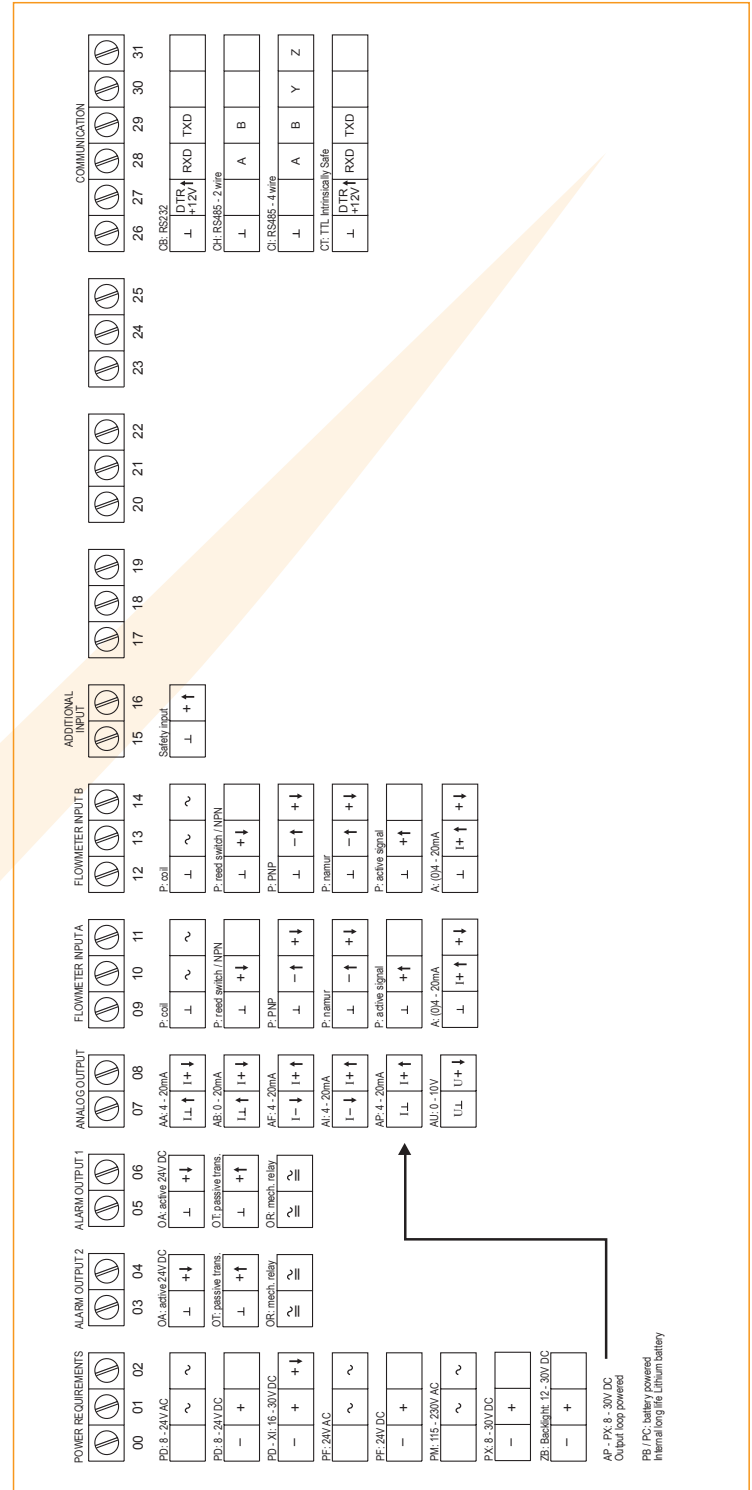

Display example - 90 x 40mm (3.5" x 1.6")



Typical wiring diagram F124-A-AP-CH-OT-(PX)

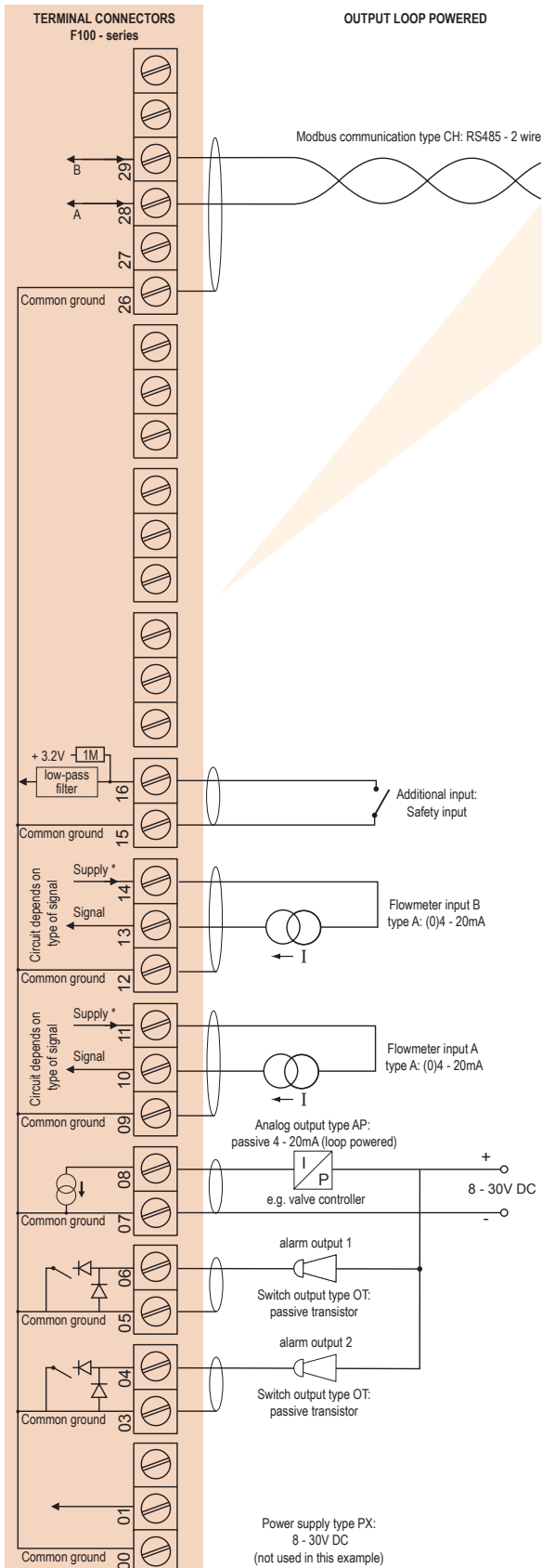

* For pulse type inputs: V_{ref} : 1.2V/3.0V available. - NO power output, available $I_{supply} < 1mA$. Note: using these ref. voltages at max. load, will reduce battery life significantly.

Typical wiring diagram F124-P-AP-CH-PF

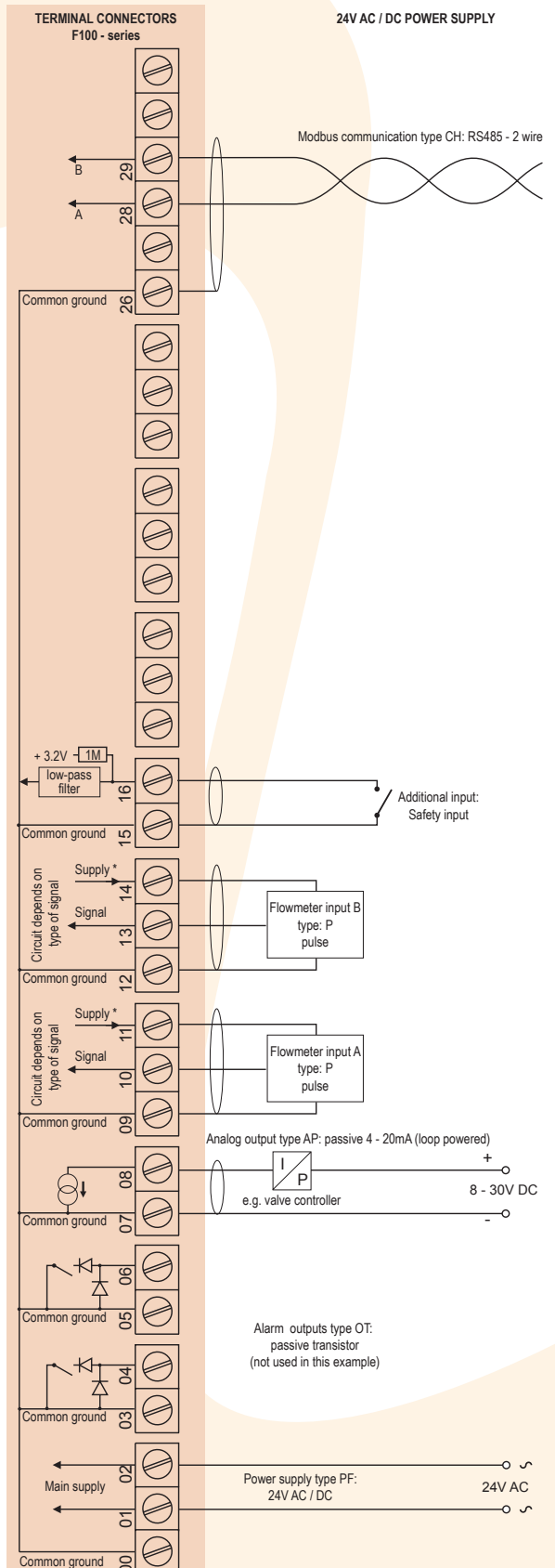

* U_{max} sensor is 2V below U_{supply}
 U_{max} sensor: 8.2V requires 10VDC(8VAC) U_{supply}
 12V requires 14VDC(10VAC) U_{supply}
 24V requires 26VDC(18VAC) U_{supply}

Typical wiring diagram F124-P-AA-CB-OA-PD

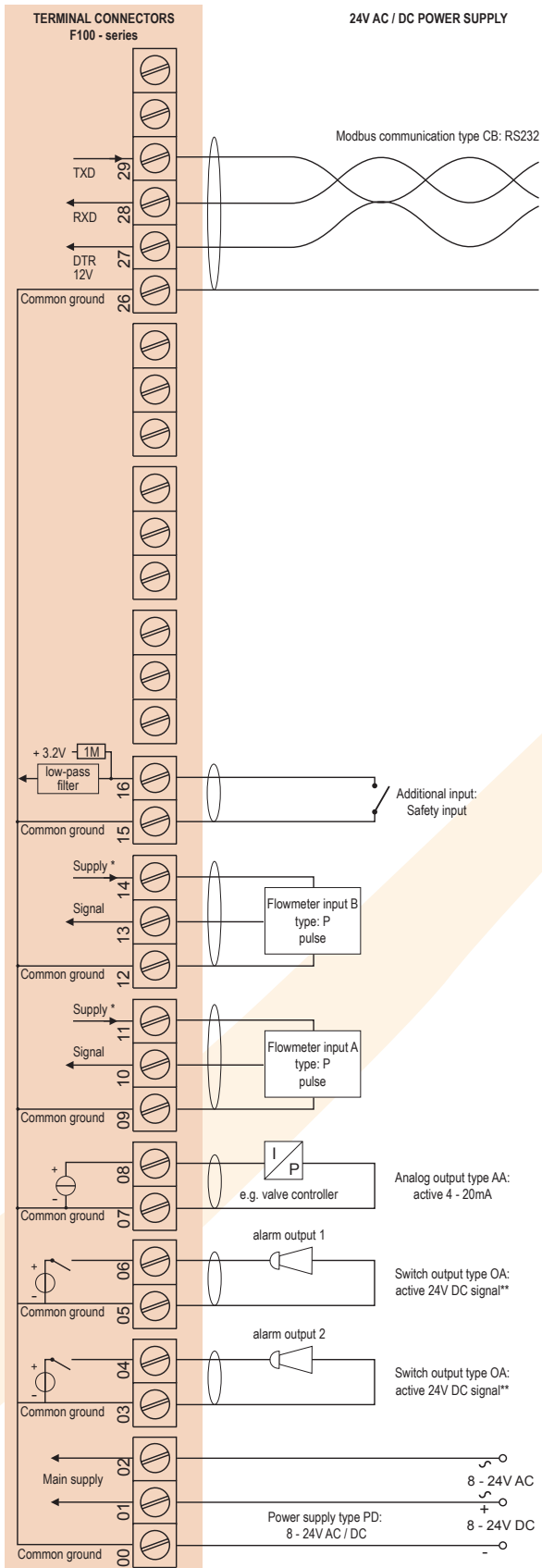

* U_{max} sensor is 2V below U_{supply}
 U_{max} sensor: 8.2V requires 10VDC(8VAC) U_{supply}
 12V requires 14VDC(10VAC) U_{supply}
 24V requires 26VDC(18VAC) U_{supply}

** Requires min. 24V power supply

Typical wiring diagram F124-A-AI-CI-OR-PM

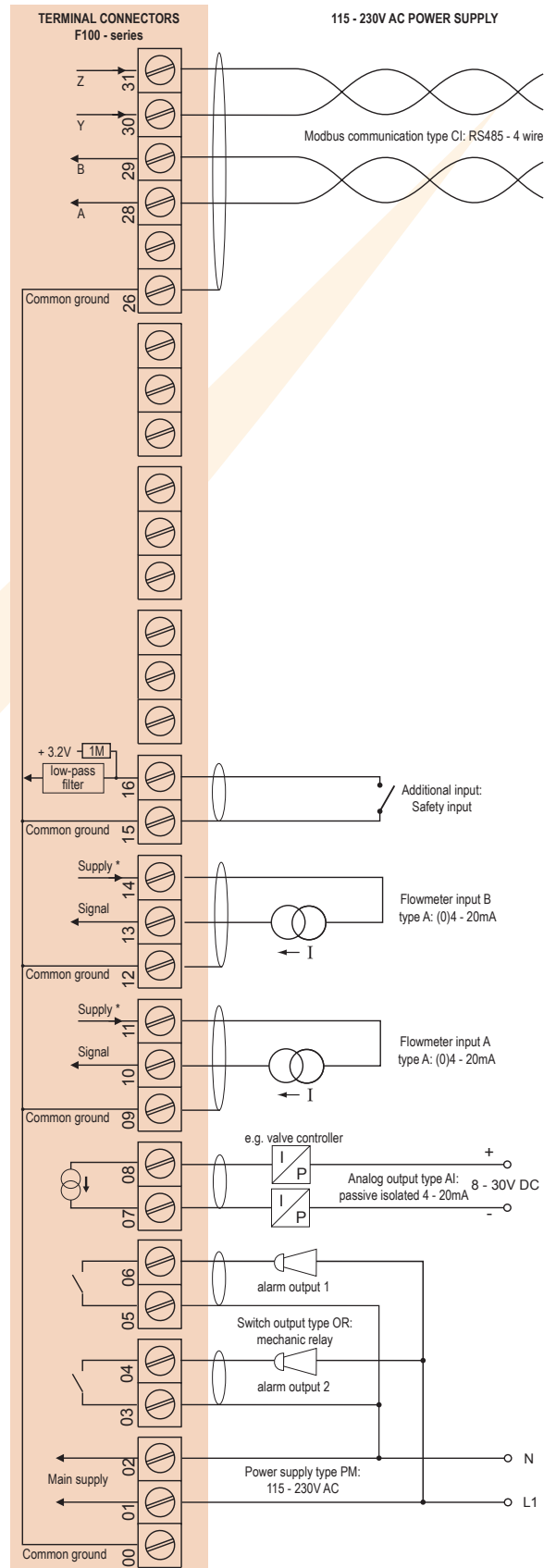

*Supply voltage: 1.2 / 3.2 / 8.2 / 12 / 24V DC to sensor

Hazardous area applications

The F124-XI has been certified according ATEX and IECEx by DEKRA for use in Intrinsically Safe applications with an ambient temperature of -40°C to +70°C (-40°F to +158°F).

- The ATEX markings for gas and dust applications are:

II 1 G Ex ia IIB/IIC T4 Ga
II 1 D Ex ia IIIC T100 °C Da.

- The IECEx markings for gas and dust applications are: **Ex ia IIC/IIB T4 Ga** and **Ex ia IIIC T100 °C Da.**

It is allowed to connect up to six barriers in IIB/IIIC applications or one barrier in IIC applications. Consult the certificate for the maximum input and output values of the circuits. Full functionality of the F124 remains available, including 8.2V sensor excitation for e.g. Namur sensors (type PD) and the Modbus communication type CT.

An ATEX approved flame proof Ex d enclosure is available as well. Please contact your supplier for further details.

Certificate of conformity KEMA 03ATEX1074 X • IECEx DEK 11.0042X



Configuration example IIB / IIIC and IIC - F124-P-AP-OT-(PX)-XI - Output loop powered unit

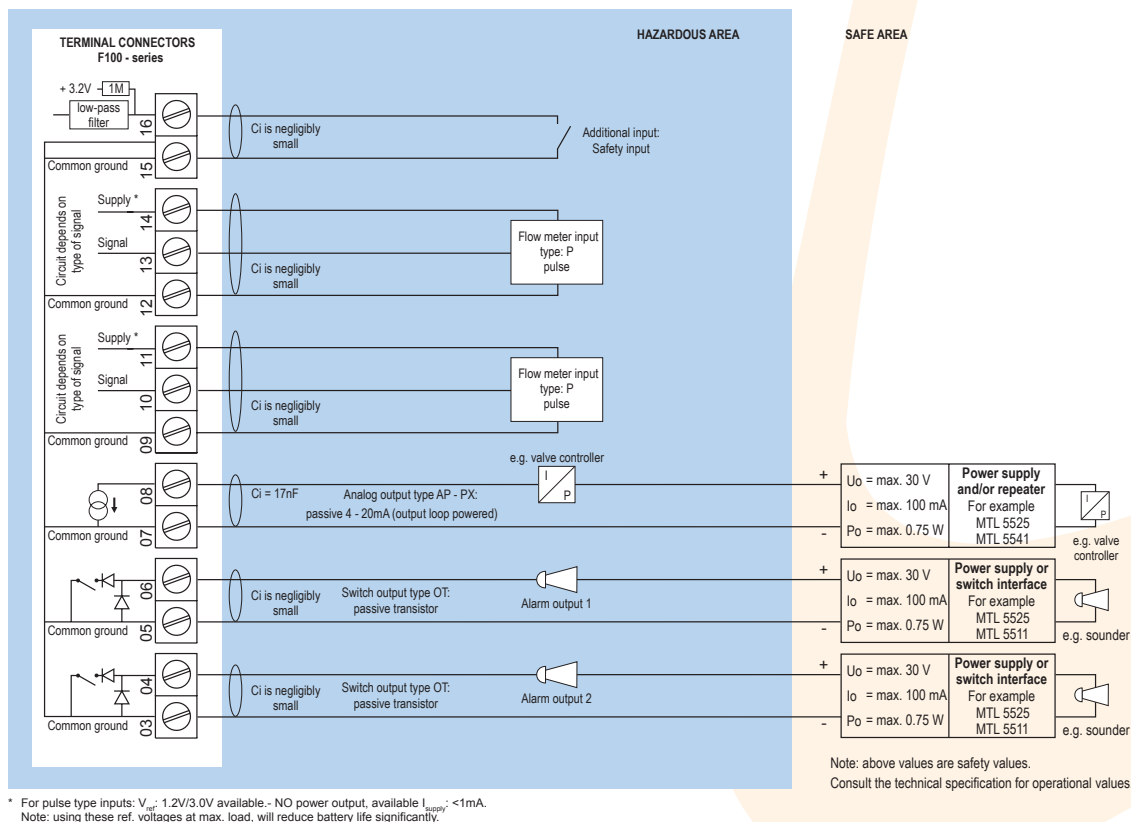

Configuration example IIB / IIIC and IIC - F124-A-AP-CT-OT-PD-XI - Power requirement 16 - 30V DC

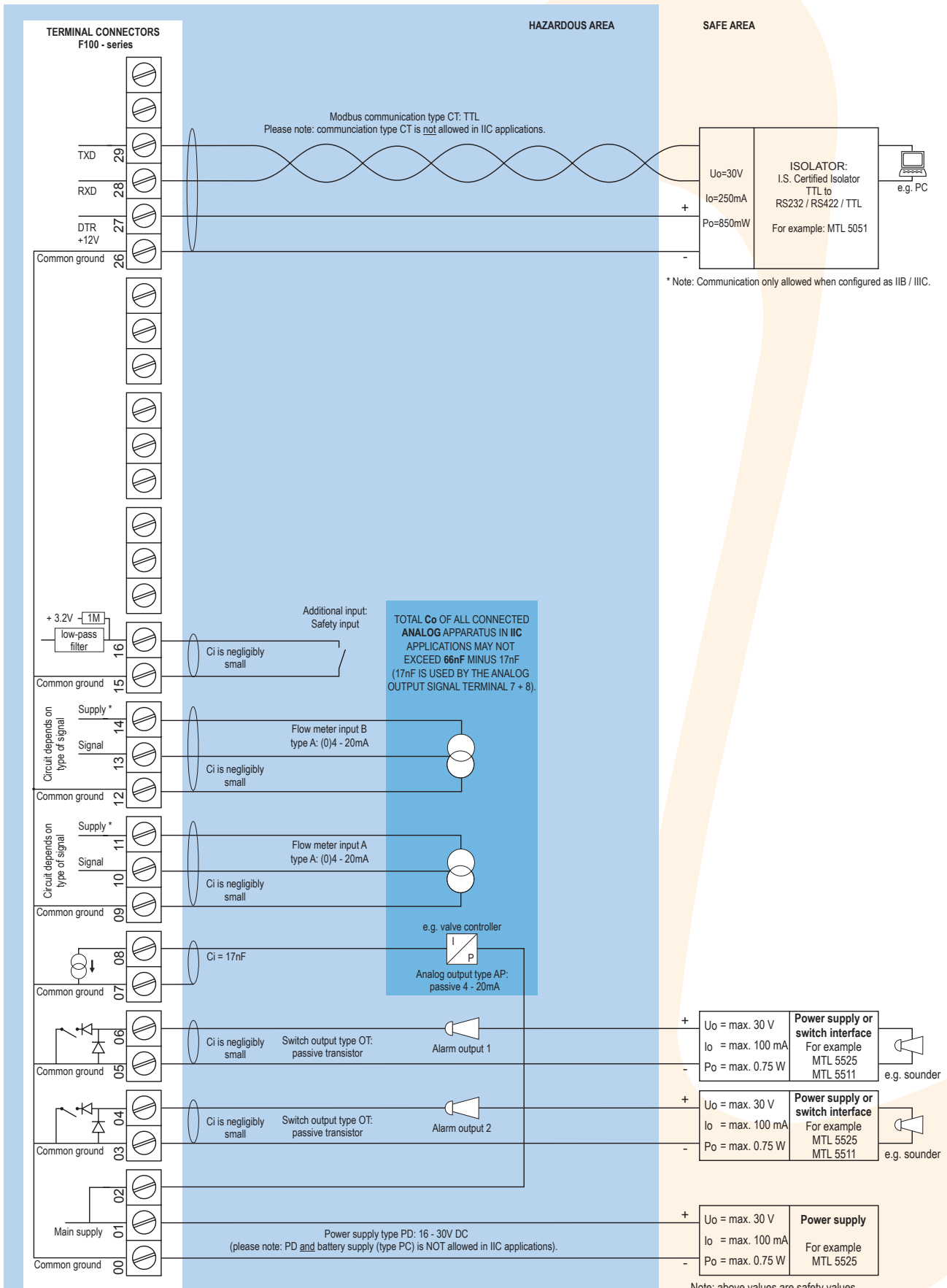

* Note power supply type PD: the supply voltage to pulse sensors is maximum 8.7V (U_o=max 8.7V I_o=max 25mA P_o=max 150mW) and to analog sensors as connected to terminal 1 (internally linked).

Configuration example IIB / IIIC - F124-P-AF-CT-OT-PD-XI - Power requirement 16 - 30V DC

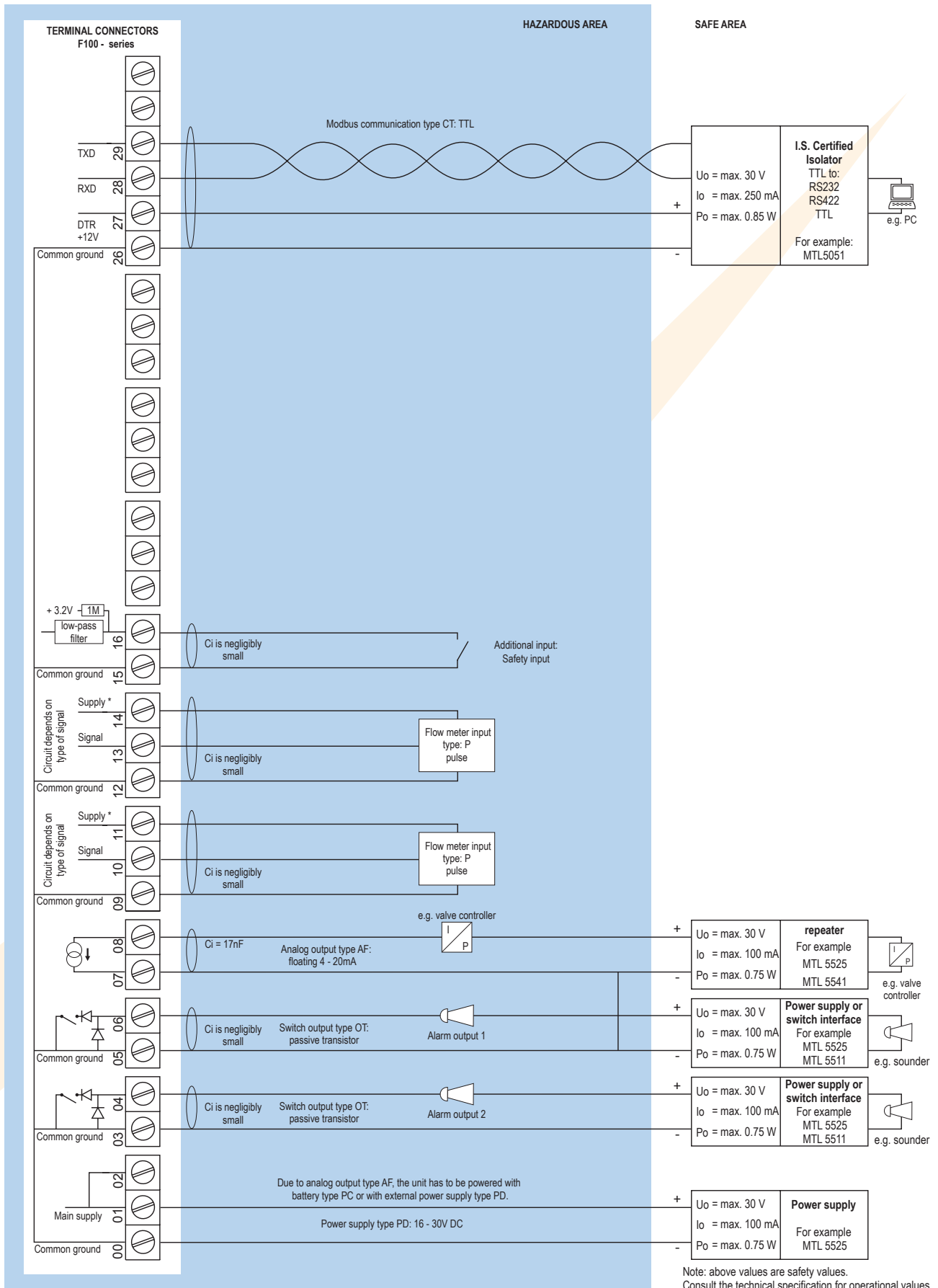

Technical specification

General

Display	
Type	High intensity reflective numeric and alphanumeric LCD, UV-resistant.
Dimensions	90 x 40mm (3.5" x 1.6").
Digits	Seven 17mm (0.67") and eleven 8mm (0.31") digits. Various symbols and measuring units.
Refresh rate	User definable: fast, 1sec, 3sec, 15sec, 30sec, off.
Option ZB	Transflective LCD with white LED-backlight. Good readings in full sunlight and darkness.
Note ZB	Only available for safe area applications.

Ambient temperature

Safe areas	-40°C to +80°C (-40°F to +176°F).
Intrinsically Safe	-40°C to +70°C (-40°F to +158°F).

Power requirements

Type AP	Analog output loop powerd, 8 - 30V DC. Power consumption max 0.5 Watt.
Type PB	Long life Lithium battery - life-time depends upon settings and configuration - up to 5 years. (requires PD or PX)
Type PC	Intrinsically Safe long life lithium battery - life-time depends upon settings and configuration - up to 5 years. (requires XI and PD or PX)
Type PD	8 - 24V AC / DC ± 10%. Power consumption max. 5 Watt. Intrinsically Safe: 16 - 30V DC; power consumption max. 1 Watt.
Type PF	24V AC / DC ± 10%. Power consumption max. 15 Watt.
Type PM	115 - 230V AC ± 10%. Power consumption max. 15 Watt.
Type PX	8 - 30V DC. Power consumption max. 0.75 Watt.
Type ZB	12 - 30V DC ± 10%. Power consumption max. 1.5 Watt.
Note PB/PF/PM	Not available Intrinsically Safe.
Note PF/PM	The total consumption of the sensors and outputs may not exceed 400mA @ 24V.
Note	For Intrinsically Safe applications, consult the safety values in the certificate.

Sensor excitation

Type PB/PC/PX	3V DC for pulse signals and 1.2V DC for coil pick-up.
Note	This is not a real sensor supply. Only suitable for sensors with a very low power consumption like coils (sine wave) and reed-switches.
Type PD	1.2 / 3 / 8.2 / 12 / 24V DC - max. 50mA @ 24V DC. U _{max} sensor is 2V below U _{supply}
Type PD-XI	1.2 / 3 / 8.2V DC - max. 7mA @ 8.2V DC and mains power supply voltage (as connected to terminal 1).
Note	In case PD-XI and signal A: the sensor supply voltage is according to the power supply voltage connected to terminal 1. Also terminal 2 offers the same voltage.
Type PF / PM	1.2 / 3 / 8.2 / 12 / 24V DC - max. 400mA @ 24V DC.

Terminal connections

Type	Removable plug-in terminal strip. Wire max. 1.5mm ² and 2.5mm ² .
------	---

Data protection

Type	EEPROM backup of all settings. Data retention at least 10 years.
Password	Configuration settings can be password protected.

Directives & Standards

EMC	Directive 2014/30/EU, FCC 47 CFR part 15.
Low voltage	Directive 2014/35/EU
RoHS	Directive 2011/65/EU
ATEX / IECEx	Directive 2014/34/EU, IEC 600079-0, IEC 60079-11.
IP & NEMA	EN 60529 & NEMA 250

Enclosure

General	
Window	Polycarbonate window.
Sealing	Silicone.
Control keys	Three industrial micro-switch keys. UV-resistant silicone keypad.

Aluminum wall / field mount enclosures

General	Die-cast aluminum wall/field mount enclosure IP67 / NEMA Type4X with 2-component UV-resistant coating.
Dimensions	130 x 120 x 75mm (5.12" x 4.72" x 2.95") - W x H x D.
Weight	1100 gr.
Type HA	Cable entry: 2 x PG9 and 1 x M20.
Type HL	Cable entry: 3 x 1/2" NPT.
Type HM	Cable entry: 2 x M16 and 1 x M20.
Type HN	Cable entry: 1 x M20.
Type HO	Cable entry: 2 x M20.
Type HP	Cable entry: 6 x M12.
Type HT	Cable entry: 1 x 1/2" NPT.
Type HU	Cable entry: 3 x 1/2" NPT.
Type HV	Cable entry: 4 x M20.
Type HZ	Cable entry: no holes.

GRP wall / field mount enclosures

General	GRP wall/field mount enclosure IP67 / NEMA Type4X, UV-resistant and flame retardant.
Dimensions	130 x 120 x 75mm (5.12" x 4.72" x 2.95") - W x H x D.
Weight	600 gr.
Type HD	Cable entry: no holes.
Type HE	Cable entry: 2 x Ø 16mm and 1 x Ø 20mm.
Type HF	Cable entry: 1 x Ø 22mm (7/8").
Type HG	Cable entry: 2 x Ø 20mm.
Type HH	Cable entry: 6 x Ø 12mm.
Type HJ	Cable entry: 3 x Ø 22mm (7/8").
Type HK	Flat bottom, cable entry: no holes.

Panel mount enclosures

Dimensions	130 x 120 x 60mm (5.12" x 4.72" x 2.36") - W x H x D.
Panel cut-out	115 x 98mm (4.53" x 3.86") L x H.
Type HB	Die-cast aluminum panel mount enclosure IP65 / NEMA Type4X.
Weight	600 gr.
Type HC	GRP panel mount enclosure IP65 / NEMA Type4X, UV-resistant and flame retardant.
Weight	450 gr.

Hazardous area

Intrinsically Safe (Type XI)

ATEX certification	 II 1 G Ex ia IIB/IIC T4 Ga. II 1 D Ex ia IIIC T100 °C Da.
IECEX certification	 Ex ia IIC/IIB T4 Ga. Ex ia IIIC T100 °C Da.
Ambient Ta	-40°C to +70°C (-40°F to +158°F).

Explosion proof (Type XF)

ATEX certification	 II 2 G / Ex d IIB T5 Gb. II 2 D / Ex t IIIB T100 °C Db.
Type XF	Dimensions of enclosure: 300 x 250 x 200mm (11.8" x 9.9" x 7.9") L x H x D.
Weight	Appr. 15kg.
Note	IECEX available on request.

Signal inputs

Flowmeter

Type P	Coil / sine wave (HI: 20mVpp or LO: 80mVpp - sensitivity selectable), NPN/PNP, open collector, reed-switch, Namur, active pulse signals 8 - 12 and 24V DC.
Frequency	Minimum 0Hz - maximum 7kHz for total and flow rate. Maximum frequency depends on signal type and internal low-pass filter. E.g. reed switch with low-pass filter: max. frequency 120Hz.
K-Factor	0.000010 - 9,999,999 with variable decimal position.
Low-pass filter	Available for all pulse signals.
Option ZF	coil sensitivity 10mVpp.
Type A	(0)4 - 20mA. Analog input signal can be scaled to any desired range within 0 - 20mA.
Type U	0 - 10V DC. Contact factory.
Accuracy	Resolution: 14 bit. Error < 0.025mA / ± 0.125% FS. Low level cut-off programmable.
Span	0.000010 - 9,999,999 with variable decimal position.
Update time	Four times per second.
Voltage drop	Type A: 2.5V @ 20mA.
Relationship	Linear and square root calculation.
Note	For signal type A: external power to sensor is required; e.g. type PD.

Additional input

Function	Standard available: Safety input. Terminal input to activate the predefined safety ratio.
Type IR	Internally pulled-up switch contact - NPN.
Duration	Minimum pulse duration 100msec.

Signal outputs

Communication option

Function	Reading display information, reading / writing all configuration settings.
Protocol	Modbus RTU.
Speed	1200 - 2400 - 4800 - 9600 baud.
Addressing	Maximum 255 addresses.
Type CB	RS232
Type CH	RS485 2-wire
Type CI	RS485 4-wire
Type CT	TTL Intrinsically Safe.

Analog output

Function	Controlling the ratio between flow A and B.
Accuracy	10 bit. Error < 0.05%. Analog output signal can be scaled to any desired range.
Update time	Eight times per second.
Type AA	Active 4 - 20mA output (requires PD, PF, PM or PX).
Type AB	Active 0 - 20mA output (requires PD, PF, PM or PX).
Type AF	Passive floating 4 - 20mA output for Intrinsically Safe applications (requires XI + PD).
Type AI	Passive galvanically isolated 4 - 20mA output - also available for battery powered models.
Type AP	Passive 4 - 20mA output - not isolated. Unit will be loop powered.
Type AU	Active 0 - 10V DC output (requires PD, PF, PM or PX). Requires min. 12V power supply.

Digital outputs

Function	Low or high ratio alarm output. Alarm value limits: 0 - 100%.
Type OA	Two active 24V DC transistor outputs (PNP); max. 50mA per output (requires PD, PF, PM or PX). Requires min. 24V power supply.
Type OR	Two electro-mechanical relay outputs isolated (N.O.) - max. switch power 230V AC - 0.5A (requires PF or PM).
Type OT	Two passive transistor outputs (NPN) - not isolated. Max. 50V DC - 300mA per output.

Operational

Operator functions

Displayed functions	<ul style="list-style-type: none"> Ratio setpoint in %. Actual ratio in %. Flowrate A Flowrate B Low ratio alarm value. High ratio alarm value. Operation modes: Hand, Local or Ratio. Safety mode.
---------------------	---

Flowrate

Digits	7 digits.
Units	mL, L, m³, Gallons, kg, Ton, lb, bl, cf, RND, ft³, scf, Nm³, NL, igal - no units.
Decimals	0 - 1 - 2 or 3.
Time units	/sec - /min - /hr - /day.

Control Parameters

Operation mode	Hand, Local, Ratio.
Control action	Direct / Reverse.
Proportional band	0.1 to 999,9%.
Integral time	0.1 to 6,000.0 s or OFF (0.0).
Safety output	-5.0 to 105.0% (0) = Run / (1) = Safety output.
Control output limiter	-5.0 to 105.0% for both high and low limits.

Ordering information

Standard configuration: F124-P-AP-CX-HC-IR-OT-PX-XX-ZX.

Ordering information:

F124 _ -A _ -C _ -H _ -IR _ -O _ -P _ -X _ -Z _

Flowmeter input signal

- A (0)4 - 20mA input.
- P **Pulse input: coil, npn, pnp, namur, reed-switch.**

Analog output signal

- AA Active 4 - 20mA output - requires PD, PF, PM or PX.
- AB Active 0 - 20mA output - requires PD, PF, PM or PX.
- AF I.S. floating 4 - 20mA output - requires XI + PD.
- AI Isolated 4 - 20mA output.
- AP **Passive 4 - 20mA output, loop powered unit.**
- AU Active 0 - 10V DC output - requires PD, PF, PM or PX.

Communication

- CB Communication RS232 - Modbus RTU.
- CH Communication RS485 - 2-wire - Modbus RTU.
- CI Communication RS485 - 4-wire - Modbus RTU.
- CT Intrinsically Safe TTL - Modbus RTU.
- CX **No communication.**

Panel mount enclosures - IP65 / NEMA Type4X

- HB Aluminum enclosure.
- HC **GRP enclosure.**

GRP field / wall mount enclosures - IP67 / NEMA Type4X

- HD Cable entry: no holes.
- HE Cable entry: 2 x Ø 16mm & 1 x Ø 20mm.
- HF Cable entry: 1 x Ø 22mm (7/8").
- HG Cable entry: 2 x Ø 20mm.
- HH Cable entry: 6 x Ø 12mm.
- HJ Cable entry: 3 x Ø 22mm (7/8").
- HK Flat bottom, cable entry: no holes.

Aluminum field / wall mount enclosures - IP67 / NEMA Type4X

- HA Cable entry: 2 x PG9 + 1 x M20.
- HL Cable entry: 2 x 1/2"NPT.
- HM Cable entry: 2 x M16 + 1 x M20.
- HN Cable entry: 1 x M20.
- HO Cable entry: 2 x M20.
- HP Cable entry: 6 x M12.
- HT Cable entry: 1 x 1/2"NPT.
- HU Cable entry: 3 x 1/2"NPT.
- HV Cable entry: 4 x M20.
- HZ Cable entry: no holes.

Additional input signal

- IR **Remote control input as safety input.**

Digital output signals

- OA Two active transistor outputs - requires PD, PF, PM or PX.
- OR Two mechanical relay outputs - requires PF or PM.
- OT **Two passive transistor outputs - standard configuration.**

Power requirements

- PD 8 - 24V AC/DC + sensor supply - with XI: 16 - 30V DC.
- PF 24V AC/DC + sensor supply.
- PM 115 - 230V AC + sensor supply.
- PX **Basic power supply 8 - 30V DC (no real sensor supply).**

Additional battery supply (optional)

- PB Lithium battery powered - requires PD, or PX.
- PC Lithium battery powered - Intrinsically Safe - requires XI, and PD or PX.

Hazardous area

- XI Intrinsically Safe, according ATEX and IECEx.
- XF Ex d enclosure - 3 keys according ATEX.
- XX **Safe area only.**

Other options

- ZB Backlight.
- ZF Coil input 10mVpp.
- ZX **No options.**

The bold marked text contains the standard configuration.

Available Intrinsically Safe.

Specifications are subject to change without notice.



Quality
ISO 9001

www.dekra-seal.com

Fluidwell bv

P.O. Box 6
5460 AA - Veghel - The Netherlands
Telephone: +31 (0)413 343 786
Telefax: +31 (0)413 363 443
email: displays@fluidwell.com
Internet: www.fluidwell.com

